

Aldom
G R O U P

Muhtelif Profiller
Various Profiles

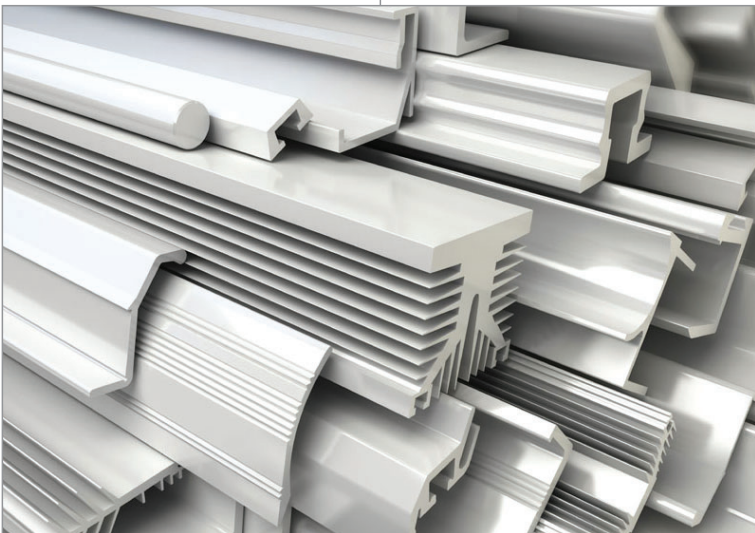

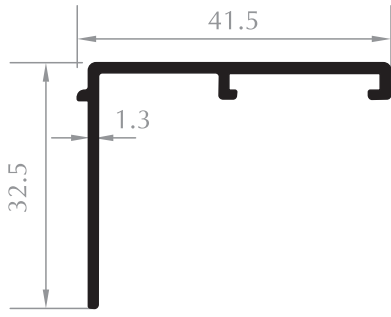

PERVAZ PROFİLİ
SILL PROFILE
Kod/Code :CE3028
Ağırlık/Weight:0,294 kg/m



KAPAK PROFİLİ
CAP PROFILE
Kod/Code :CE3032
Ağırlık/Weight:1,128 kg/m

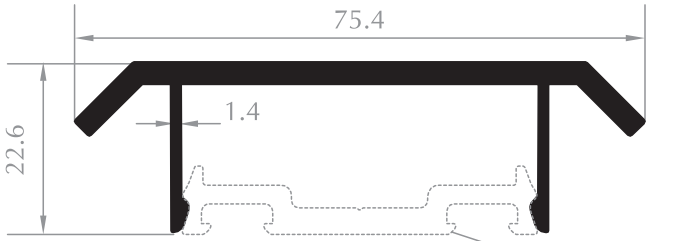

KAPAK PROFİLİ
CAP PROFILE
Kod/Code :CE3033
Ağırlık/Weight:0,813 kg/m

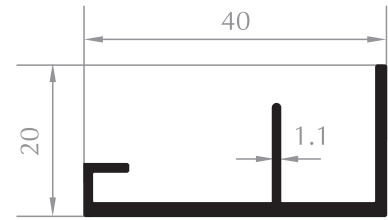

20x40 F PROFİL
20x40 F PROFILE
Kod/Code :CE4002
Ağırlık/Weight:0,336 kg/m

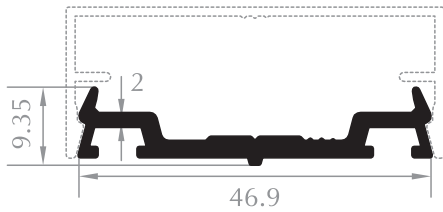

BASKI ÇITASI
COVER PROFILE
Kod/Code :CE3034
Ağırlık/Weight:0,408 kg/m

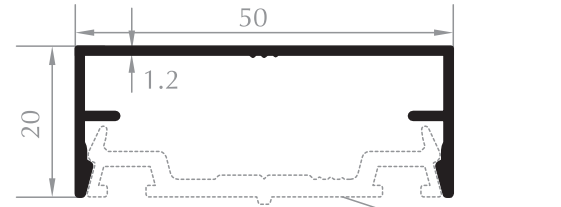

KAPAK PROFİLİ
CAP PROFILE
Kod/Code :CE3035
Ağırlık/Weight:0,332 kg/m



CEPHE PROFİLİ
FACADE PROFILE
Kod/Code :CE4001
Ağırlık/Weight:0,536 kg/m

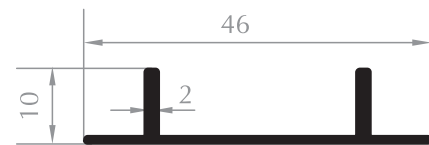

46x10 KANATLI U PROFİLİ
46x10 U PROFILE
Kod/Code :CE4003
Ağırlık/Weight:0,297 kg/m

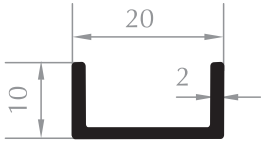

10x20 U PROFİLİ
10x20 U PROFILE
Kod/Code :CE4006
Ağırlık/Weight:0,174 kg/m



10x30 U PROFİLİ
10x30 U PROFILE
Kod/Code :CE4007
Ağırlık/Weight:0,214 kg/m

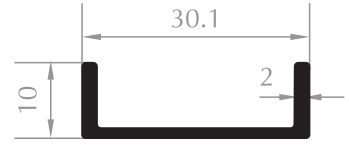

10x30 U PROFİLİ
10x30 U PROFILE
Kod/Code :CE4004
Ağırlık/Weight:0,208 kg/m

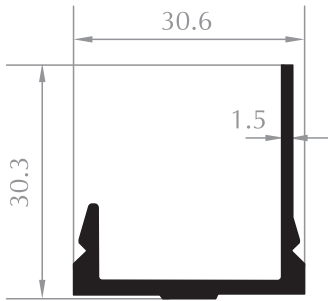

BASKI PROFİLİ
COVER PROFILE
Kod/Code :CE4008
Ağırlık/Weight:0,336 kg/m

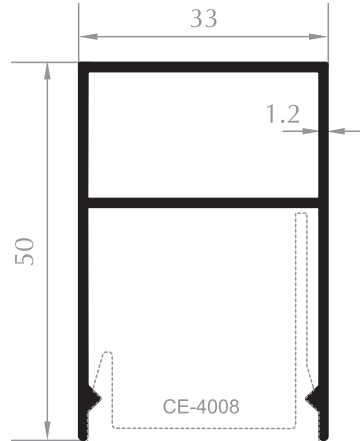

KAPAK PROFİLİ
CAP PROFILE
Kod/Code :CE4009
Ağırlık/Weight:0,544 kg/m

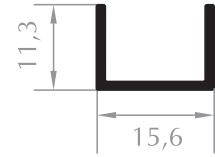

U PROFİLİ
U PROFILE
Kod/Code :CE1414
Ağırlık/Weight:0,119 kg/m

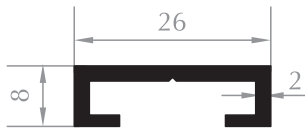

CEPHE PROFİLİ
FACADE PROFILE
Kod/Code :CE4012
Ağırlık/Weight:0,238 kg/m

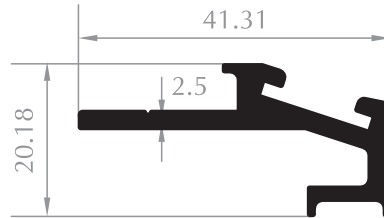

CEPHE PROFİLİ
FACADE PROFILE
Kod/Code :CE4013
Ağırlık/Weight:0,529 kg/m

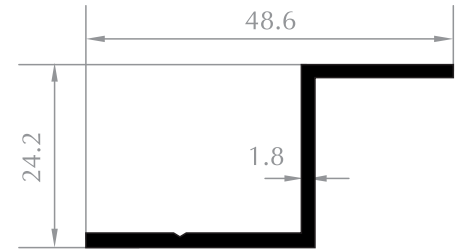

Z PROFİLİ
Z PROFILE
Kod/Code :CE4011
Ağırlık/Weight:0,336 kg/m

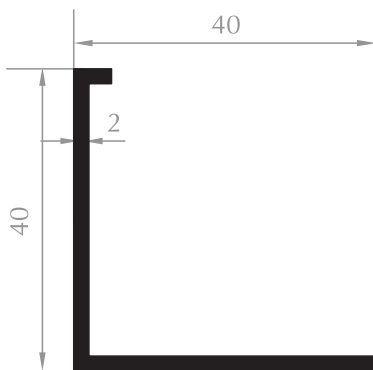

40x40 PERVAZ KÖŞEBENT
40x40 SILL PROFILE
Kod/Code :CE4015
Ağırlık/Weight:0,439 kg/m

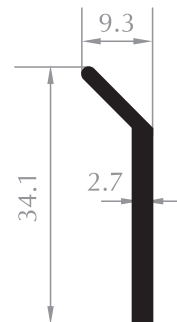

MEMBRAN ÇITASI
MEMBRANE PROFILE
Kod/Code :CE4010
Ağırlık/Weight:0,245 kg/m

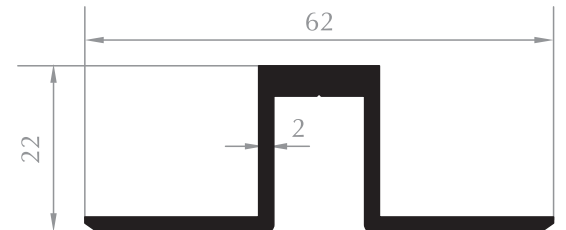

OMEGA PROFİL
OMEGA PROFILE
Kod/Code :CE4014
Ağırlık/Weight:0,610 kg/m

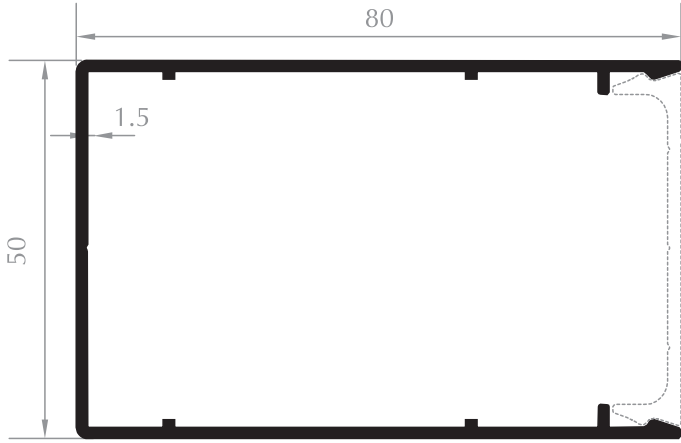

KAPAK PROFİLİ
CAP PROFILE

Kod/Code :CE4017
Ağırlık/Weight:0,891 kg/m

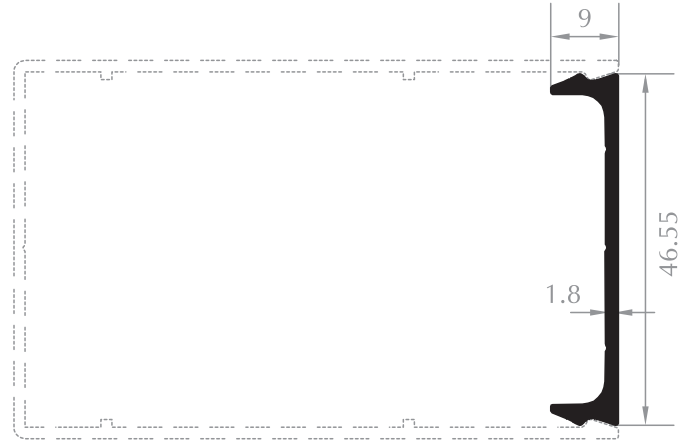

BASKI PROFİLİ
COVER PROFILE

Kod/Code :CE4018
Ağırlık/Weight:0,311 kg/m

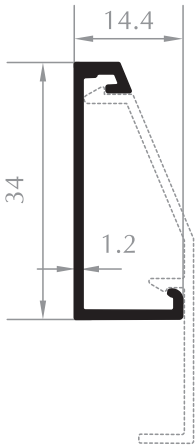

CEPHE PERVAZ PROFİLİ
FACADE SILL PROFILE

Kod/Code :CE4019
Ağırlık/Weight:0,201 kg/m

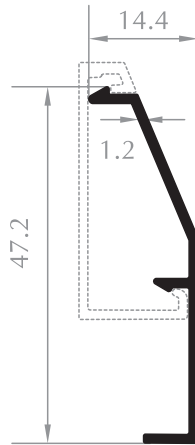

CEPHE PERVAZ PROFİLİ
FACADE SILL PROFILE

Kod/Code :CE4020
Ağırlık/Weight:0,211 kg/m

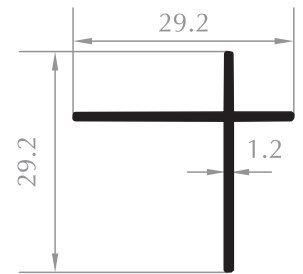

KÖŞE PROFİLİ
CORNER PROFILE

Kod/Code :CE4021
Ağırlık/Weight:0,187 kg/m

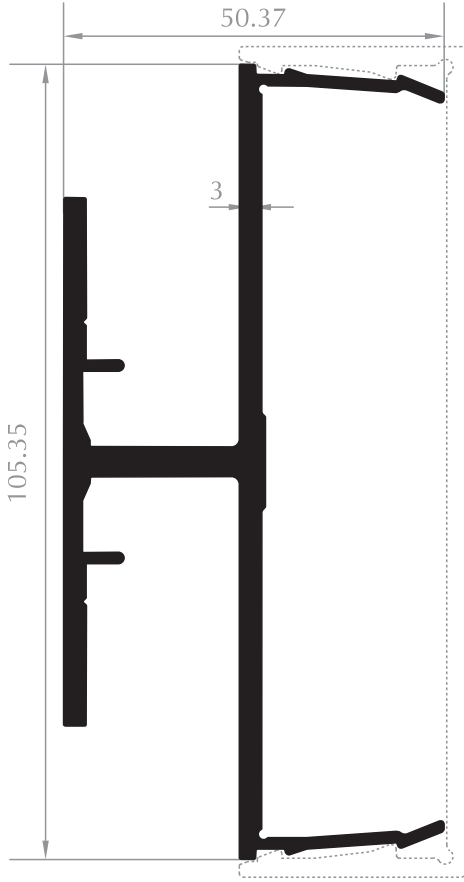

BASKI PROFİLİ
COVER PROFILE
Kod/Code :CE4024
Ağırlık/Weight: 1,884 kg/m

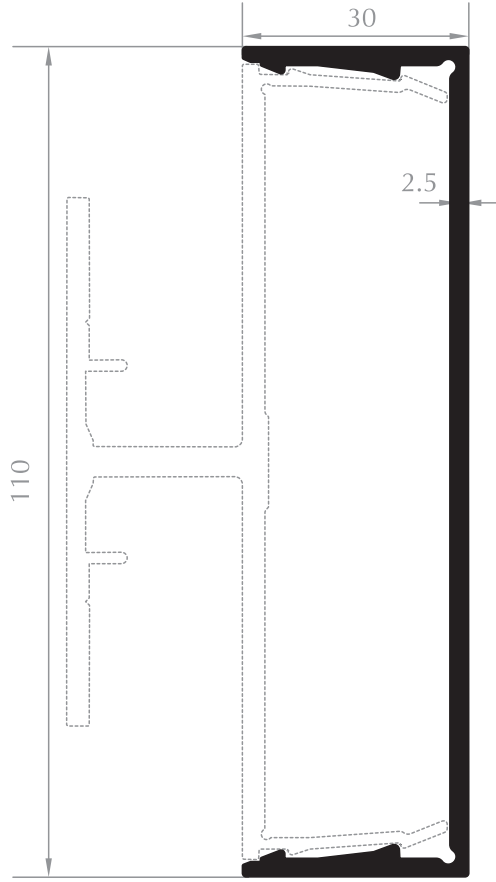

KAPAK PROFİLİ
CAP PROFILE
Kod/Code :CE4025
Ağırlık/Weight: 1,155 kg/m

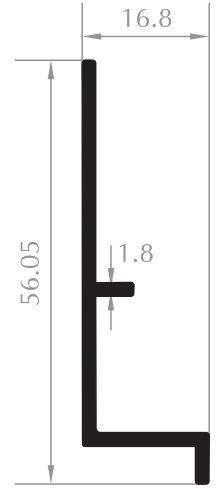

PERVAZ PROFİLİ
SILL PROFILE
Kod/Code :CE4032
Ağırlık/Weight: 0,370 kg/m

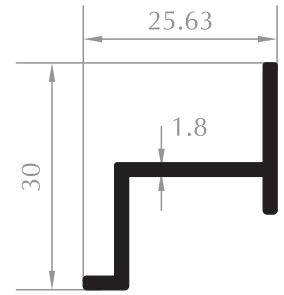

PERVAZ PROFİLİ
SILL PROFILE
Kod/Code :CE4031
Ağırlık/Weight: 0,286 kg/m

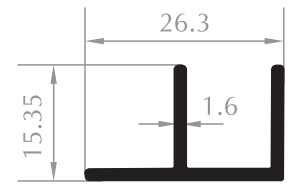

F PROFİL
F PROFILE
Kod/Code :CE4030
Ağırlık/Weight: 0,230 kg/m

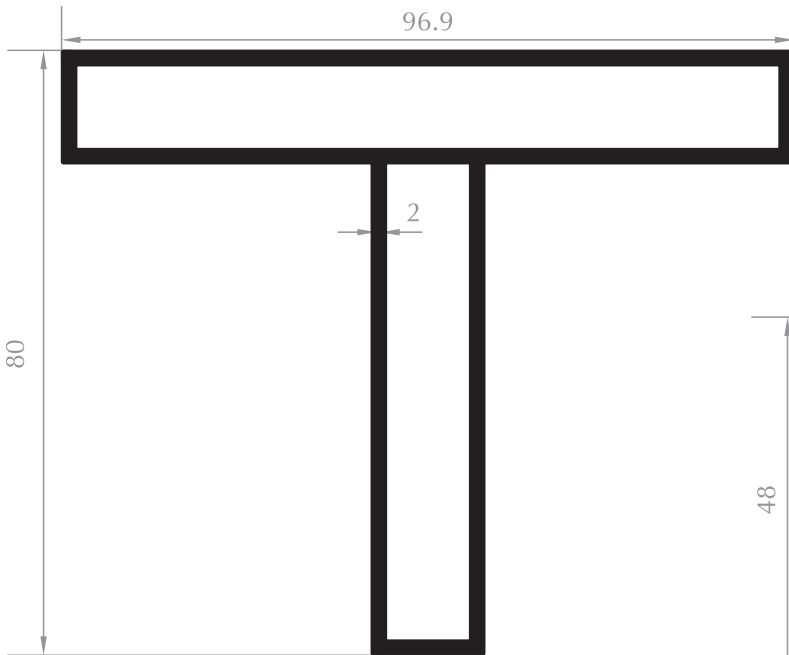

T PROFİL
T PROFILE
Kod/Code :CE4026
Ağırlık/Weight: 1,933 kg/m

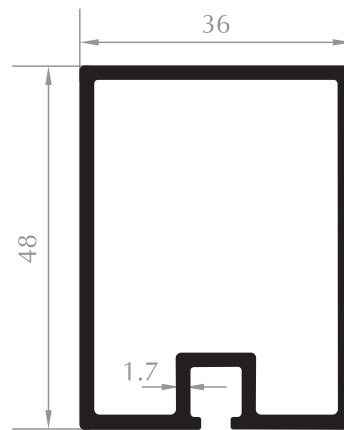

KUTU PROFİLİ
BOX PROFILE
Kod/Code :CE4033
Ağırlık/Weight: 0,862 kg/m



BASKI PROFİLİ
COVER PROFILE
Kod/Code :CE4028
Ağırlık/Weight:0,367 kg/m

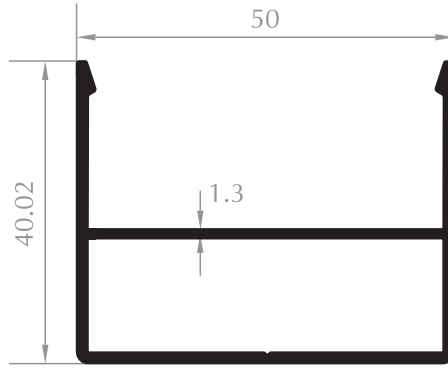

KAPAK PROFİLİ
CAP PROFILE
Kod/Code :CE4034
Ağırlık/Weight:0,691 kg/m

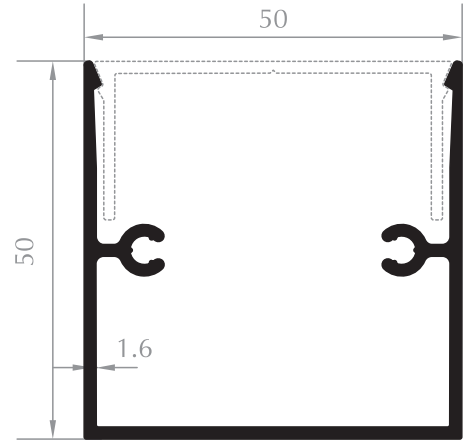

KAPAK PROFİLİ
CAP PROFILE
Kod/Code :CE4027
Ağırlık/Weight:0,769 kg/m

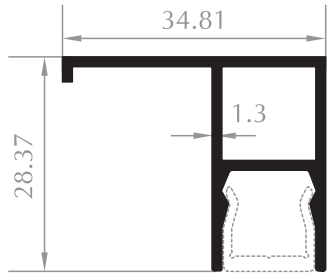

DERZ PROFİLİ
JOINT PROFILE
Kod/Code :MH1970
Ağırlık/Weight:0,381 kg/m

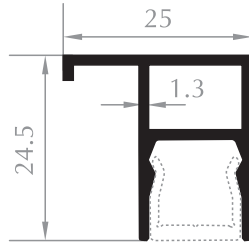

DERZ PROFİLİ
JOINT PROFILE
Kod/Code :CE4038
Ağırlık/Weight:0,320 kg/m

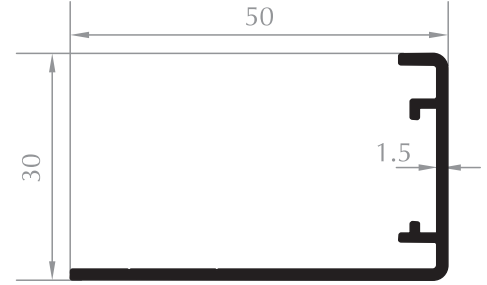

PERVAZ PROFİLİ
SILL PROFILE
Kod/Code :CE4040
Ağırlık/Weight:0,372 kg/m

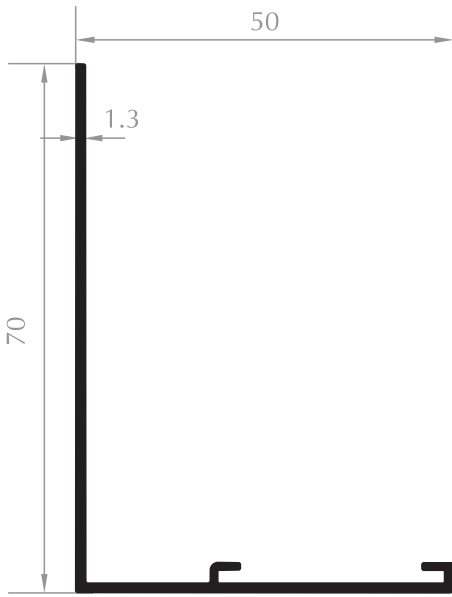

PERVAZ PROFİLİ
SILL PROFILE
Kod/Code :CE4029
Ağırlık/Weight:0,450 kg/m

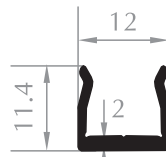

DERZ ÇITA PROFİLİ
JOINT PROFILE
Kod/Code :CE4016
Ağırlık/Weight:0,116 kg/m

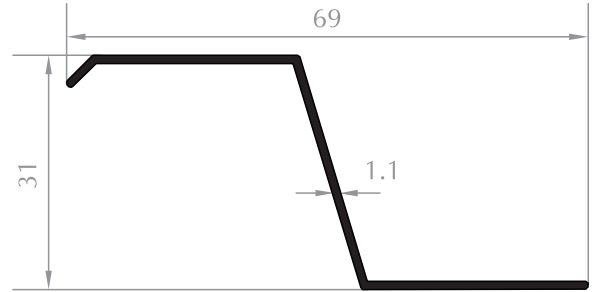

Z PROFİLİ
Z PROFILE
Kod/Code :MH1934
Ağırlık/Weight:0,276 kg/m

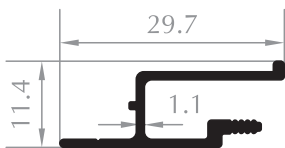

GERGİ TAVAN PROFİLİ
CEILING PROFILE
Kod/Code :MH1916
Ağırlık/Weight:0,188 kg/m

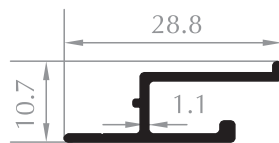

GERGİ TAVAN PROFİLİ
CEILING PROFILE
Kod/Code :MH1917
Ağırlık/Weight:0,160 kg/m

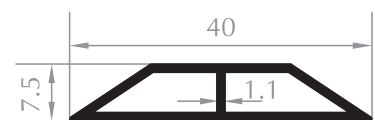

ANO ÇİTASI
PLASTER WALL LATH PROFILE
Kod/Code :MH1923
Ağırlık/Weight:0,250 kg/m

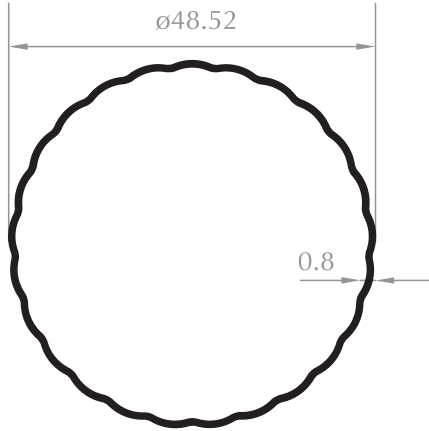

48'LİK SOBA BORUSU
STOVE PIPE
Kod/Code :MH1928
Ağırlık/Weight:0,328 kg/m

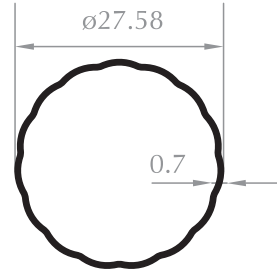

28'LİK SOBA BORUSU
STOVE PIPE
Kod/Code :MH1927
Ağırlık/Weight:0,160 kg/m

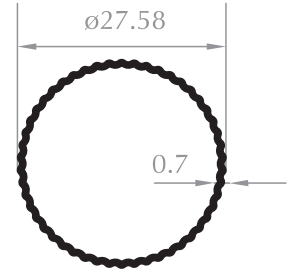

28'LİK SOBA BORUSU
STOVE PIPE
Kod/Code :MH1963
Ağırlık/Weight:0,195 kg/m

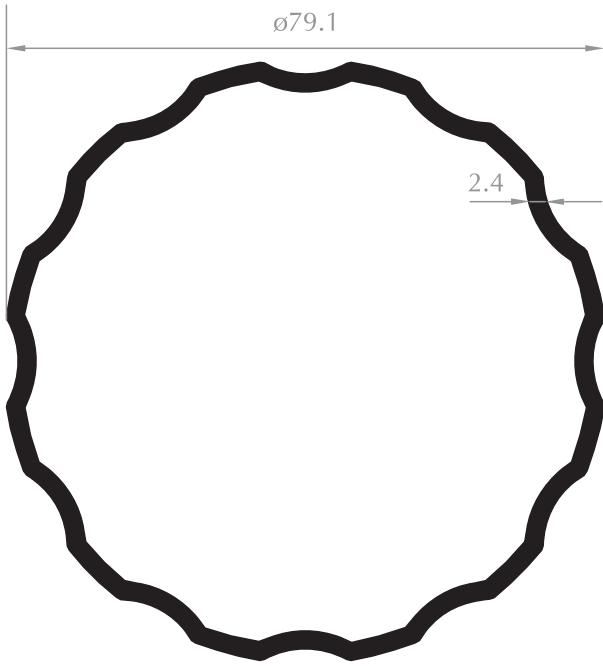

80'LİK YİVLİ BORU PROFİLİ
STOVE PIPE
Kod/Code :MH1957
Ağırlık/Weight:1,620 kg/m

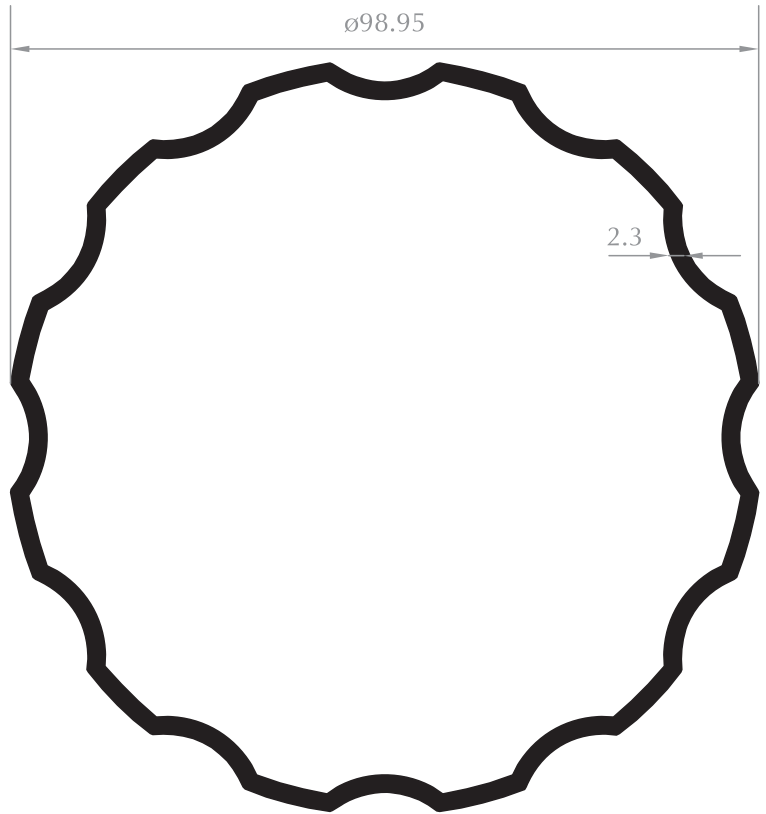

100'LÜK YİVLİ BORU PROFİLİ
STOVE PIPE
Kod/Code :MH1958
Ağırlık/Weight:1,995 kg/m

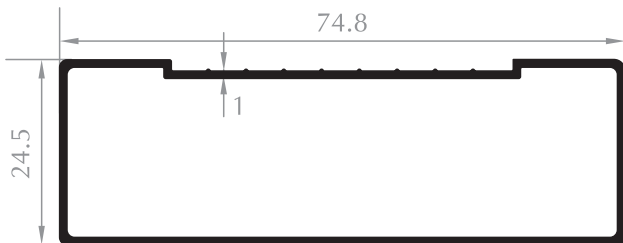

MERDİVEN PROFİLİ
STAIRS PROFILE
Kod/Code :MH1925
Ağırlık/Weight:0,531 kg/m

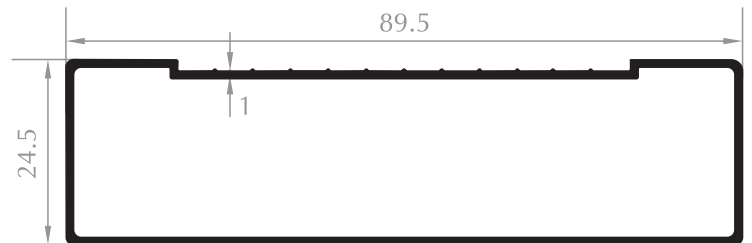

MERDİVEN PROFİLİ
STAIRS PROFILE
Kod/Code :MH1926
Ağırlık/Weight:0,611 kg/m

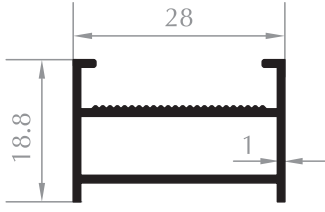

ZEMİN PROFİLİ
FLOORING PROFILE
Kod/Code :MH1101
Ağırlık/Weight:0,268 kg/m

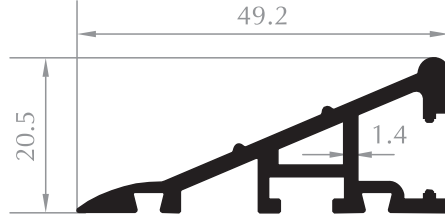

ZEMİN PROFİLİ
FLOORING PROFILE
Kod/Code :MH1102
Ağırlık/Weight:0,575 kg/m

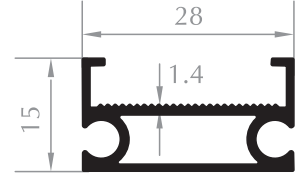

ZEMİN PROFİLİ
FLOORING PROFILE
Kod/Code :MH1103
Ağırlık/Weight:0,303 kg/m

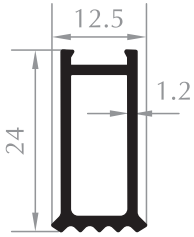

SIYIRICI PROFİL
VARIOUS PROFILE
Kod/Code :MH1104
Ağırlık/Weight:0,219 kg/m

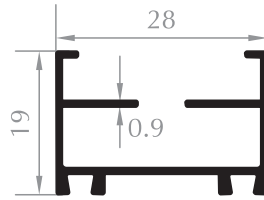

HALATLI FİTİLLİ EKO PROFİLİ
VARIOUS PROFILE
Kod/Code :MH1105
Ağırlık/Weight:0,250 kg/m

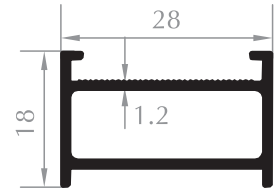

ZEMİN PROFİLİ
FLOORING PROFILE
Kod/Code :MH1106
Ağırlık/Weight:0,324 kg/m

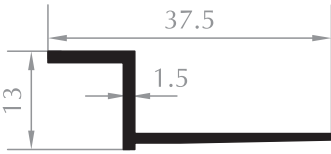

FAYANS ÇİTASI
TILE PROFILE
Kod/Code :MH1006
Ağırlık/Weight:0,167 kg/m

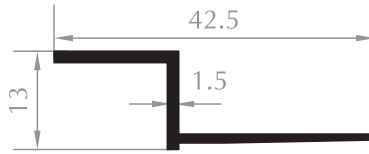

FAYANS ÇİTASI
TILE PROFILE
Kod/Code :MH1007
Ağırlık/Weight:0,188 kg/m

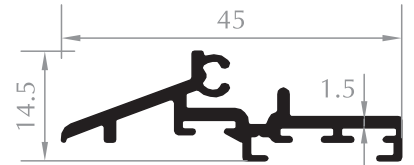

FAYANS ÇİTASI
TILE PROFILE
Kod/Code :MH1948
Ağırlık/Weight:0,343 kg/m

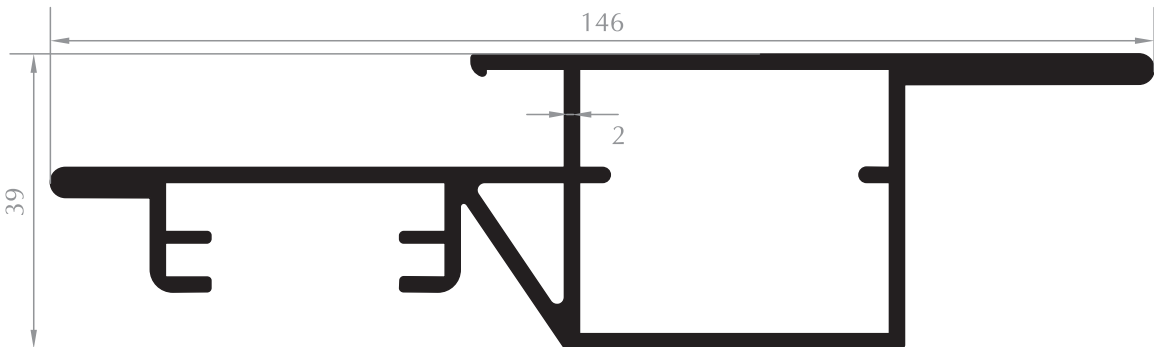

KAPI KASASI UZUN
DOOR FRAME
Kod/Code :MH1969
Ağırlık/Weight:2,165 kg/m

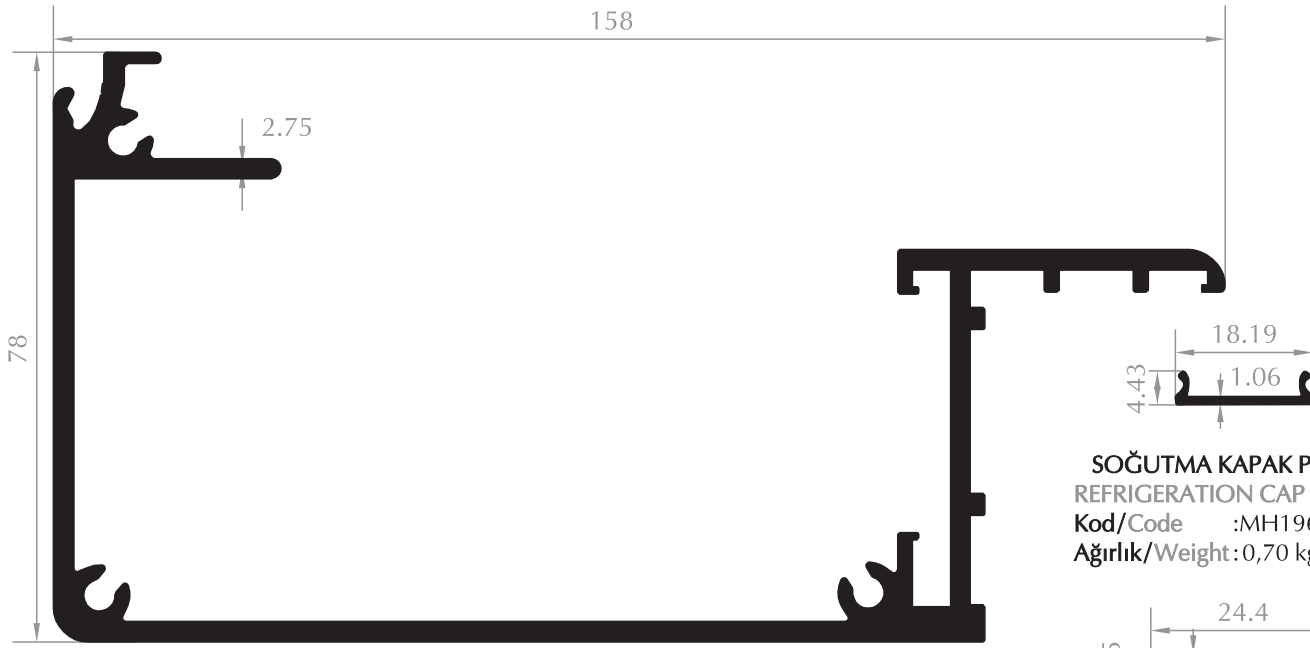

SOĞUTMA KAPAK PROFİLİ
REFRIGERATION CAP PROFILE
Kod/Code :MH1962
Ağırlık/Weight:0,70 kg/m

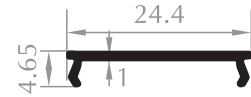

KAPAK PROFİLİ
CAP PROFILE
Kod/Code :MH1960
Ağırlık/Weight:0,98 kg/m

SOĞUTMA PROFİLİ
REFRIGERATION PROFILE
Kod/Code :MH1919
Ağırlık/Weight:2,879 kg/m

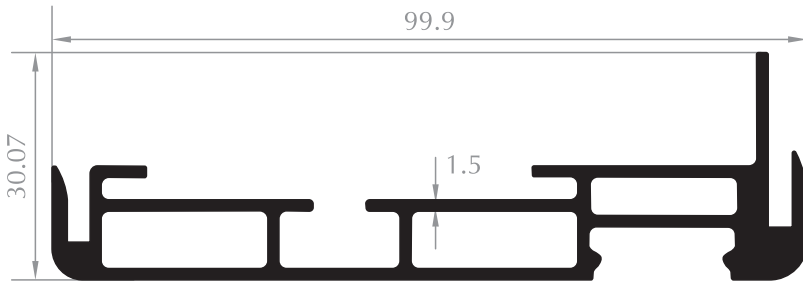

SOĞUTMA PROFİLİ
REFRIGERATION PROFILE
Kod/Code :MH1961
Ağırlık/Weight:1,377 kg/m

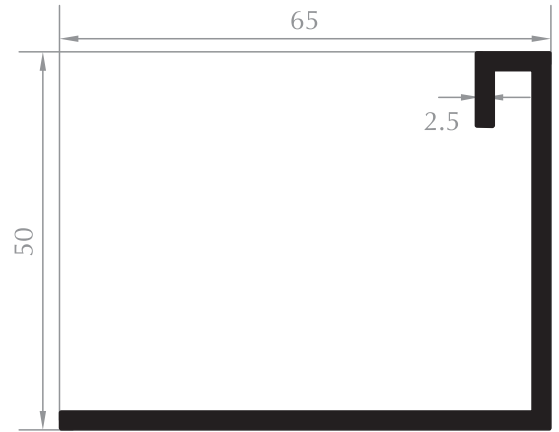

KÖŞEBENT PROFİLİ
BRACKET PROFILE
Kod/Code :MH1959
Ağırlık/Weight:0,863 kg/m

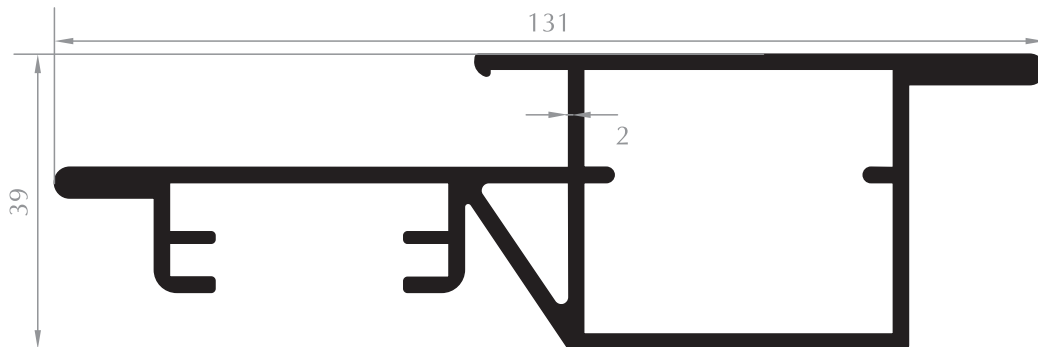

KAPI KASASI KISA
DOOR FRAME
Kod/Code :MH1968
Ağırlık/Weight:2,002 kg/m

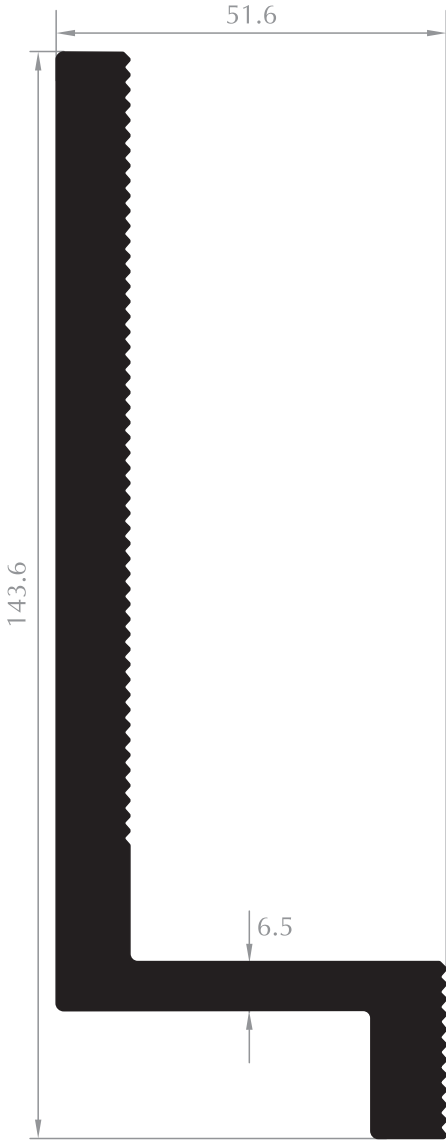

TIRTIKLİ KÖŞEBENT PROFİLİ
BRACKET PROFILE
Kod/Code :MH1964
Ağırlık/Weight:4,415 kg/m

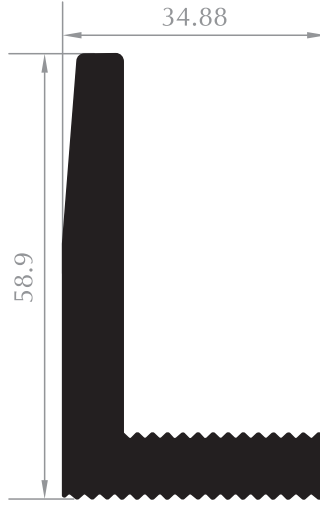

TIRTIKLİ KÖŞEBENT PROFİLİ
BRACKET PROFILE
Kod/Code :MH1965
Ağırlık/Weight:1,783 kg/m



TIRTIKLİ LAMA PROFİLİ
SHEET BAR PROFILE
Kod/Code :MH1966
Ağırlık/Weight:0,745 kg/m

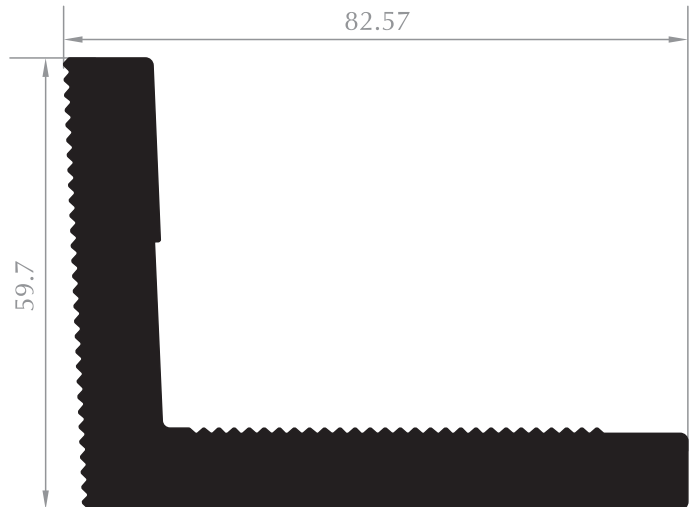

TIRTIKLİ KÖŞEBENT PROFİLİ
BRACKET PROFILE
Kod/Code :MH1967
Ağırlık/Weight:3,711 kg/m

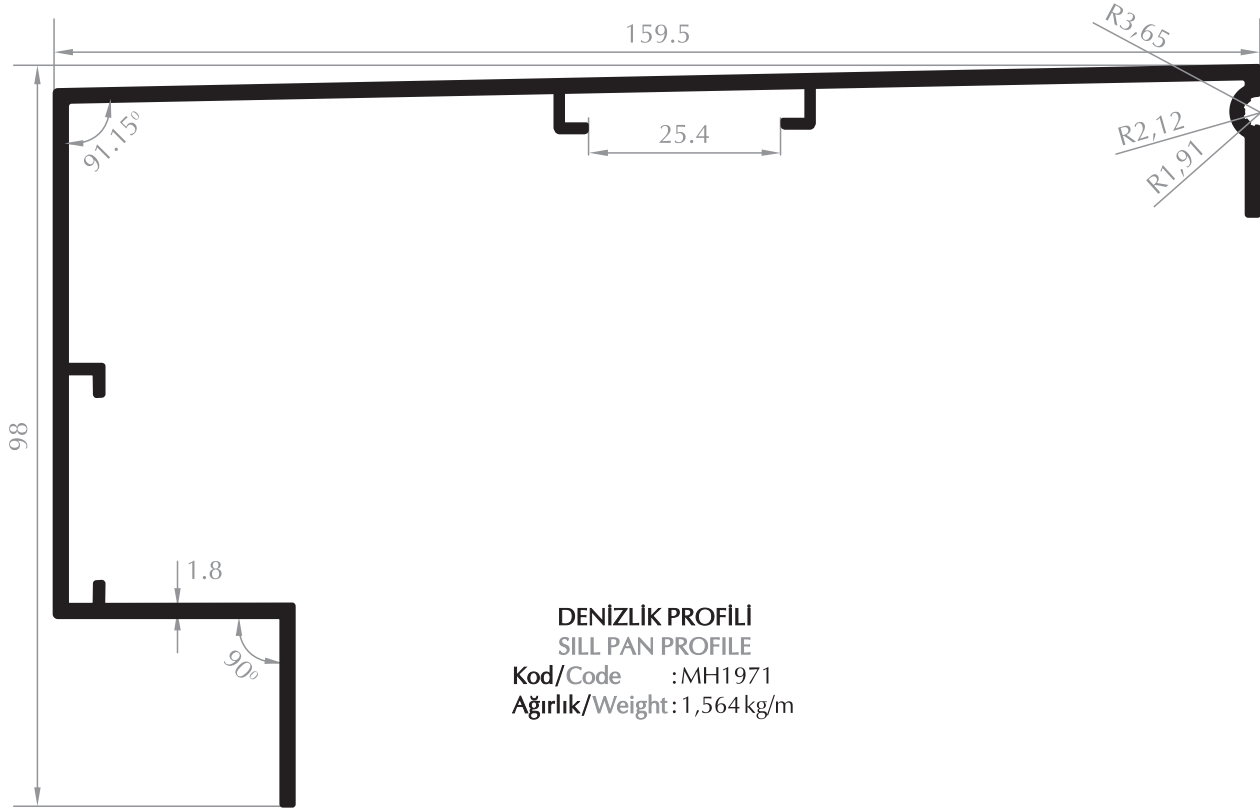

DENİZLİK PROFİLİ
SILL PAN PROFILE
Kod/Code :MH1971
Ağırlık/Weight: 1,564 kg/m

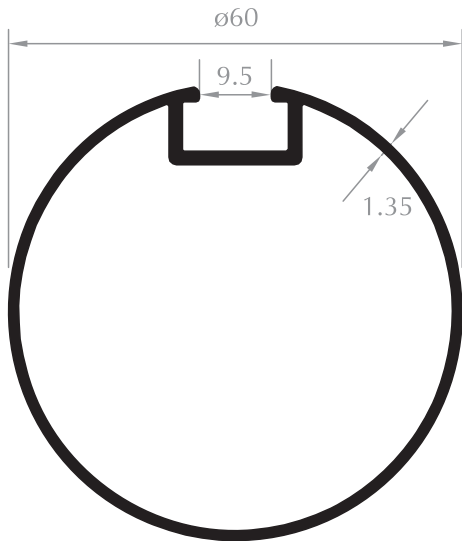

OTOMOTİV BORU PROFİLİ
AUTOMATIVE PROFILE
Kod/Code :MH1955
Ağırlık/Weight:0,793 kg/m

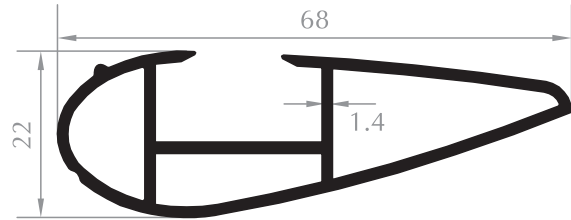

68'LİK OTOMOTİV PROFİLİ
AUTOMATIVE PROFILE
Kod/Code :MH1954
Ağırlık/Weight:0,728 kg/m

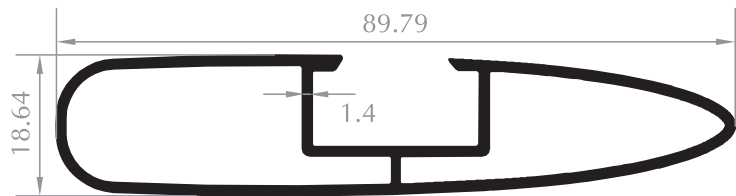

90'LİK OTOMOTİV PROFİLİ
AUTOMATIVE PROFILE
Kod/Code :MH1956
Ağırlık/Weight:0,859 kg/m

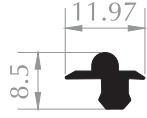

RAY PROFİLİ
RAIL PROFILE

Kod/Code :MH1988
Ağırlık/Weight:0,110 kg/m

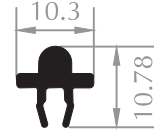

RAY PROFİLİ
RAIL PROFILE

Kod/Code :MH1989
Ağırlık/Weight:0,116 kg/m

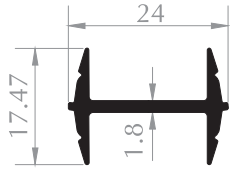

BASKI ÇITASI
COVER PROFILE

Kod/Code :MH1973
Ağırlık/Weight:0,236 kg/m

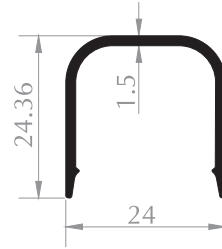

KAPAK PROFİLİ
CAP PROFILE

Kod/Code :MH1974
Ağırlık/Weight:0,256 kg/m