

## Cephe Alt Konstrüksiyon Profilleri Substructure Facade Profiles

Seramik Cephe Profilleri Ceramic Claddings

Klipsli Sistem Clip-on System

Yapıştırırmalı Sistem Stick System

Zikov Kanallı Sistem Zikov System

Poliüretan Askılı Sistem Polyurethane Suspended System

Sinterflex Cephe Profilleri Sinterflex Claddings

Terracotta Cephe Profilleri Terracotta Claddings

Kompozit Panel Cephe Profilleri Composite Panel Claddings

Kompakt Laminat Cephe Profilleri Compact Laminate Claddings

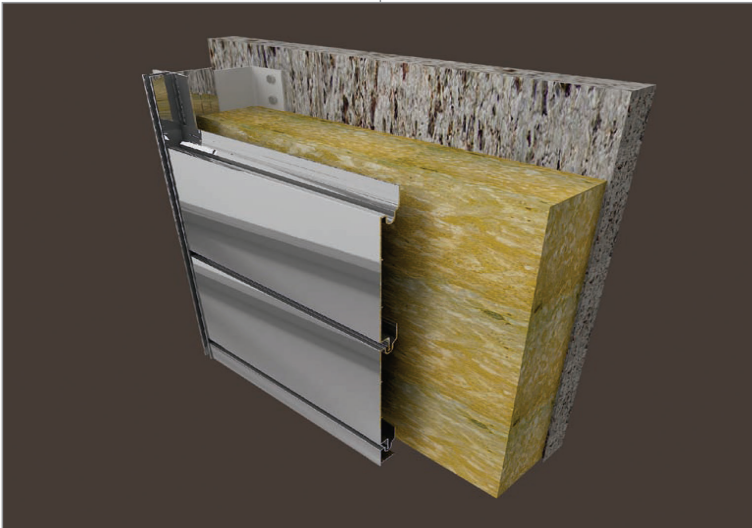

Klipsli Sistem Montaj Detayı  
Clip-on System Application Details

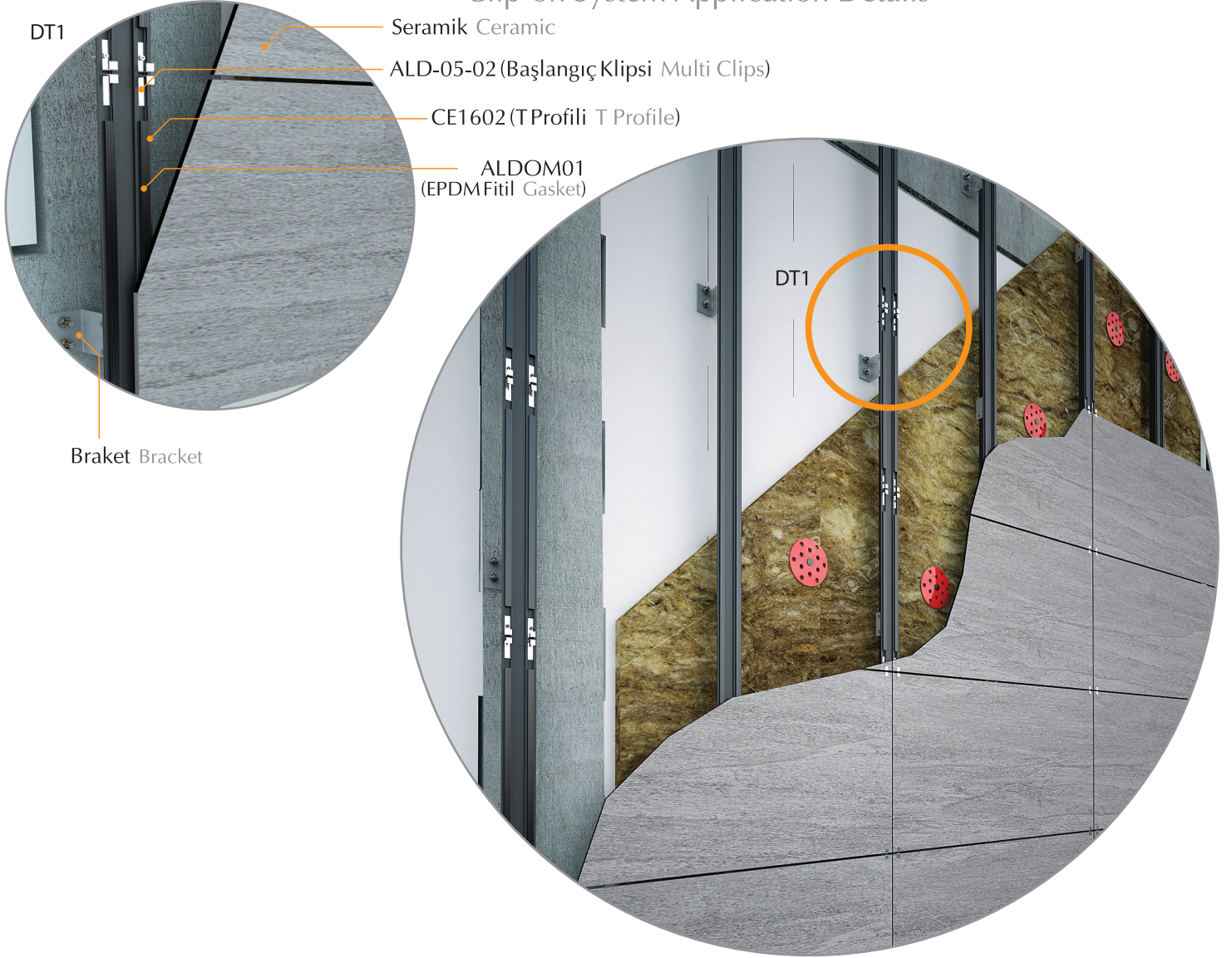

Aksesuarlar  
Accessories



**BAŞLANGIÇ KLİPSİ**  
MULTI CLIPS  
Kod/Code: ALD-05-02



**DERZ AYAR KLİPSİ**  
STAINLESS STEEL JOINT  
Kod/Code: ALD-05-03

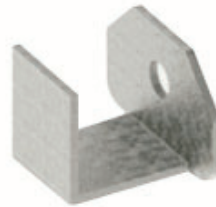

**ARA KLİPS**  
STAINLESS STEEL CLIPS  
Kod/Code: ALD-05-01



**FİTİL**  
GASKET  
Kod/Code: ALDOM-01



**TEKLİ KLİPS**  
SINGLE CLIPS  
Kod/Code: ALD-05-04



**İKİLİ KLİPS DİKEY**  
VERTICAL MULTI CLIPS WITH  
2 HEAD  
Kod/Code: ALD-05-05



**İKİLİ KLİPS YATAY**  
HORIZONTAL MULTI CLIPS WITH  
2 HEAD  
Kod/Code: ALD-05-06



**DÖRTLÜ KLİPS**  
MULTI CLIPS WITH 4 HEAD  
Kod/Code: ALD-05-07

Klipsli Sistem Montaj Detayı  
Clip-on System Application Details

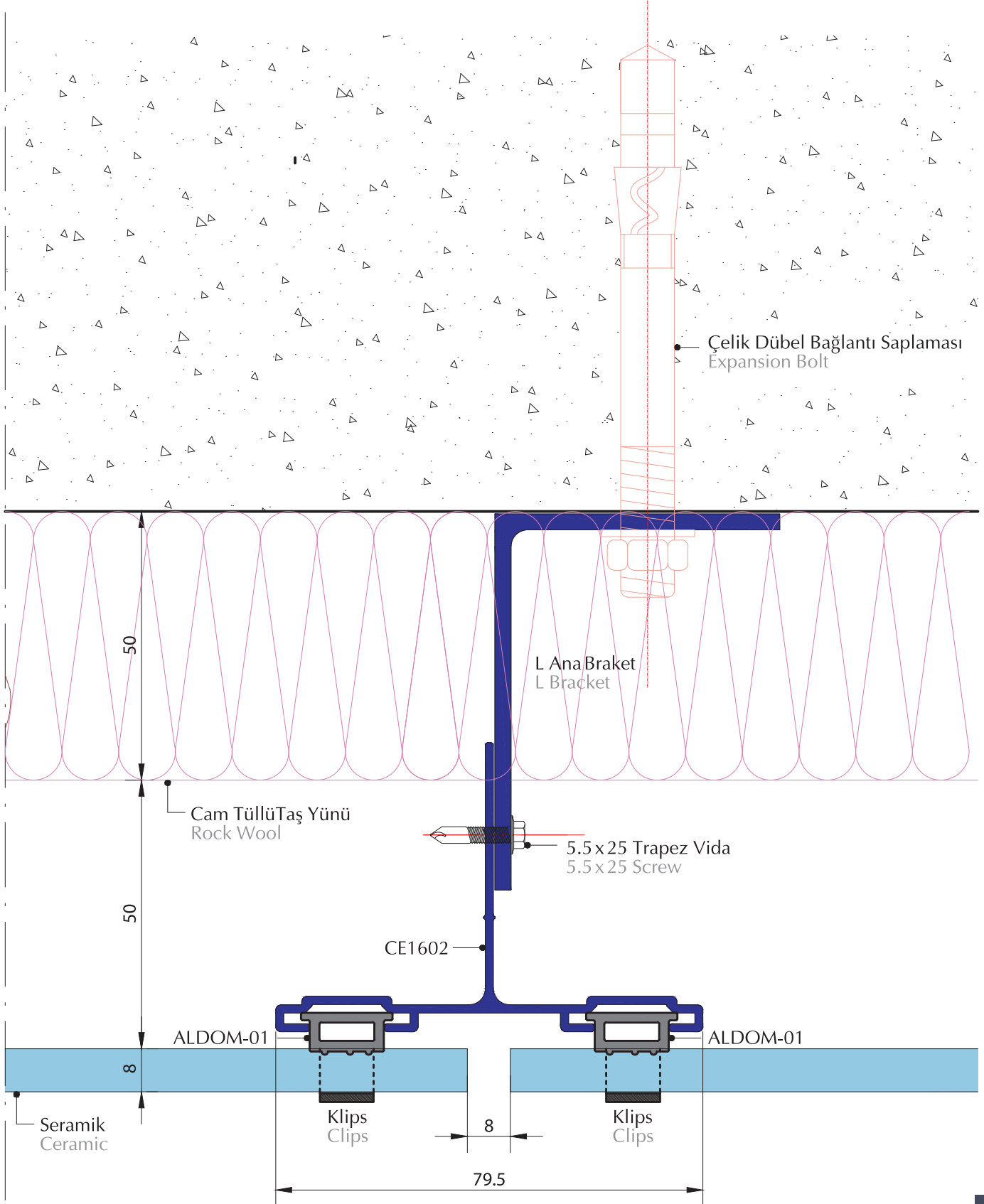

Klipsli Sistem Clip-on System

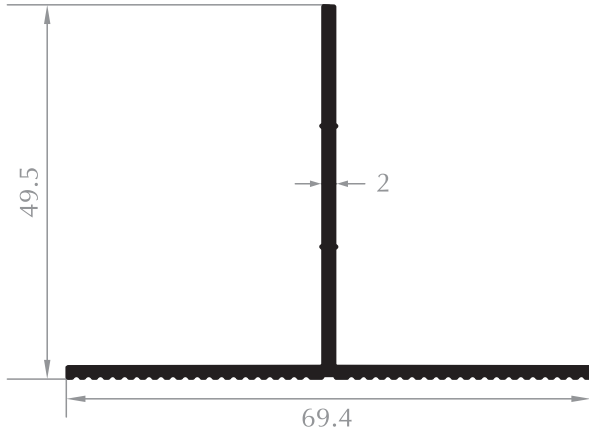

**TIRTIKLİ T  
T PROFILE**

Kod/Code :CE1401  
Ağırlık/Weight:0,618 kg/m

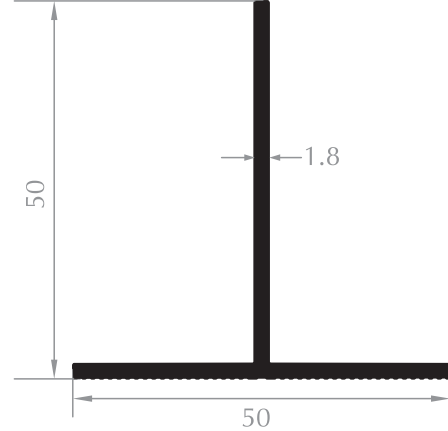

**TIRTIKLİ T  
T PROFILE**

Kod/Code :CE1416  
Ağırlık/Weight:0,507 kg/m

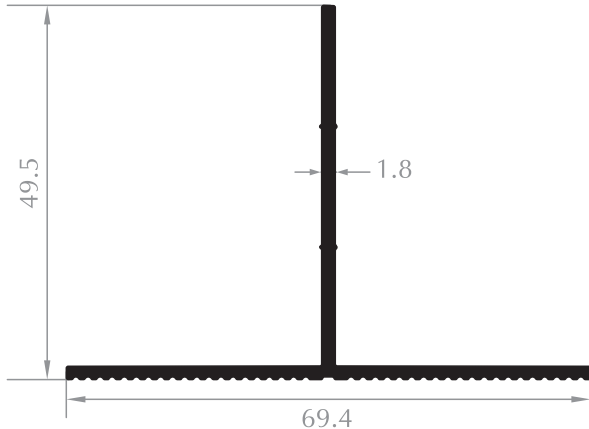

**TIRTIKLİ T  
T PROFILE**

Kod/Code :CE1406  
Ağırlık/Weight:0,545 kg/m

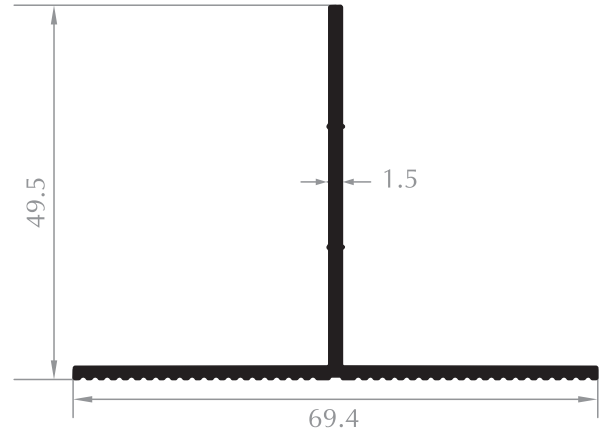

**TIRTIKLİ T  
T PROFILE**

Kod/Code :CE1407  
Ağırlık/Weight:0,451 kg/m

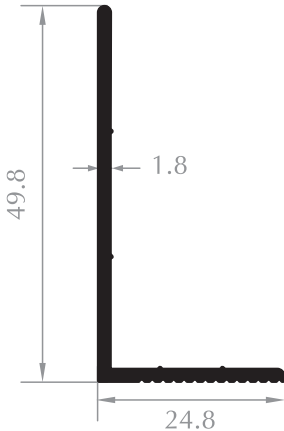

**TIRTIKLİ L  
L PROFILE**

Kod/Code :CE1404  
Ağırlık/Weight:0,350 kg/m

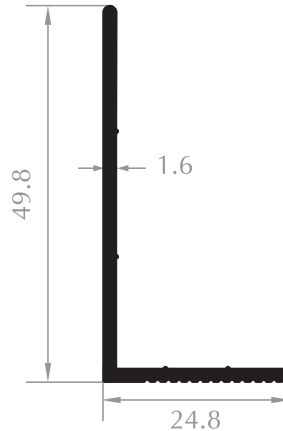

**TIRTIKLİ L  
L PROFILE**

Kod/Code :CE1405  
Ağırlık/Weight:0,312 kg/m

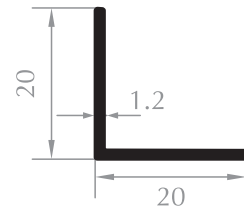

**L PROFİL  
L PROFILE**

Kod/Code :ST2006  
Ağırlık/Weight:0,126 kg/m

Klipsli Sistem Clip-on System

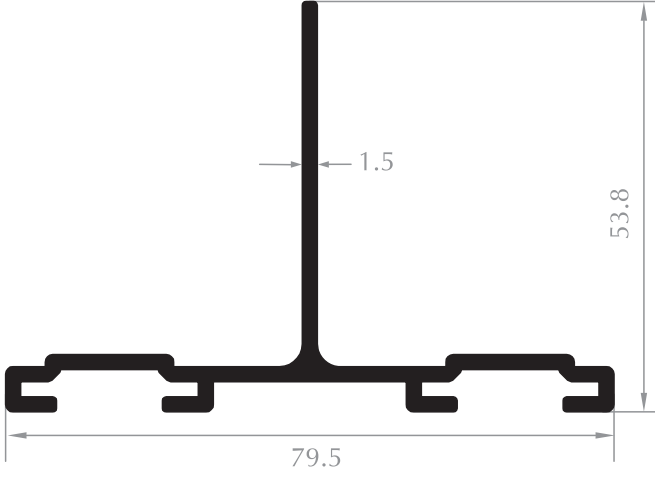

**ÇİFT KANALLI T**  
DOUBLE CHANNEL PROFILE  
Kod/Code :CE1602  
Ağırlık/Weight:0,684 kg/m

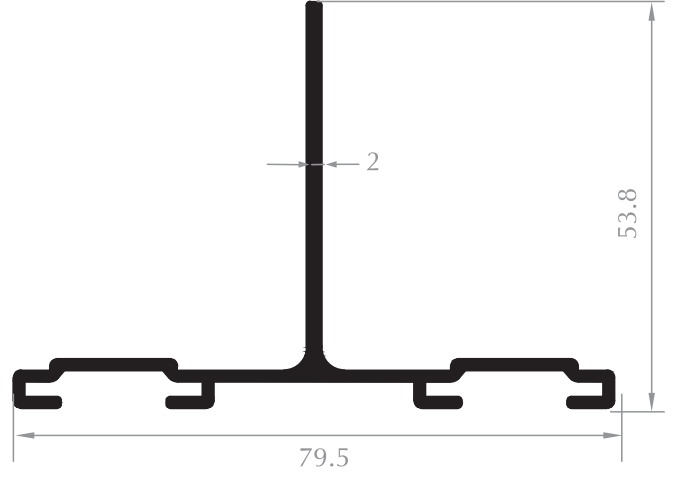

**ÇİFT KANALLI T**  
DOUBLE CHANNEL PROFILE  
Kod/Code :CE1604  
Ağırlık/Weight:0,878 kg/m

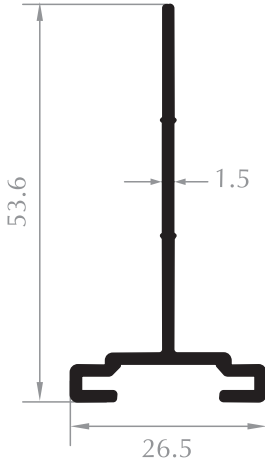

**TEK KANALLI T**  
SINGLE CHANNEL T PROFILE  
Kod/Code :CE1601  
Ağırlık/Weight:0,375 kg/m

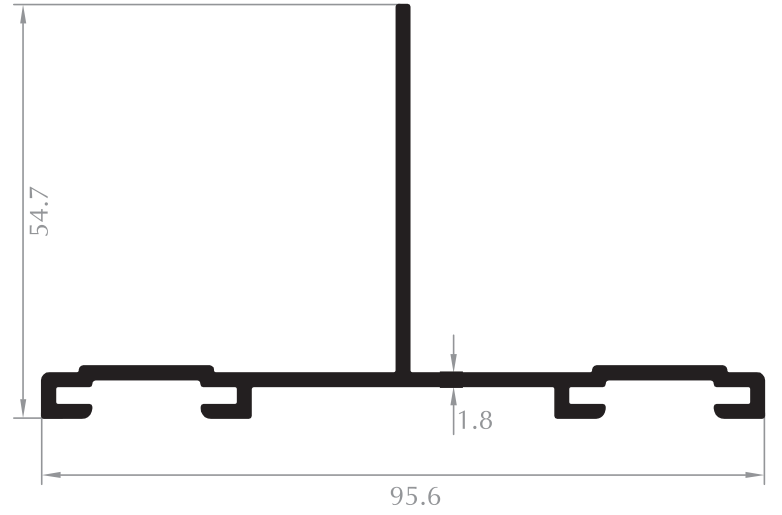

**ÇİFT KANALLI T**  
DOUBLE CHANNEL PROFILE  
Kod/Code :CE1606  
Ağırlık/Weight:0,890 kg/m

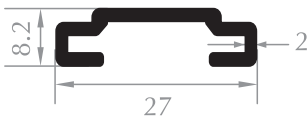

**U ÇİTA**  
U BEAD  
Kod/Code :CE1607  
Ağırlık/Weight:0,267 kg/m

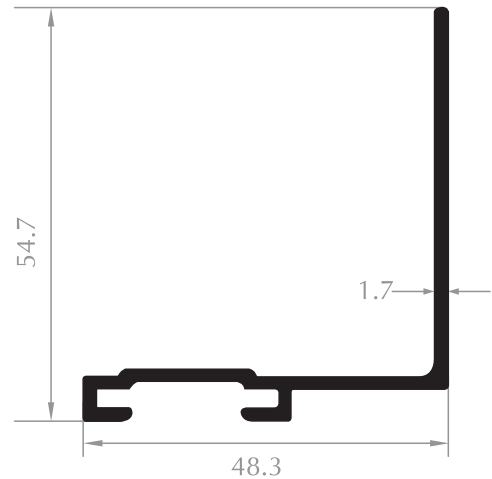

**TEK KANALLI L PROFİL**  
SINGLE CHANNEL L PROFILE  
Kod/Code :CE1605  
Ağırlık/Weight:0,530 kg/m

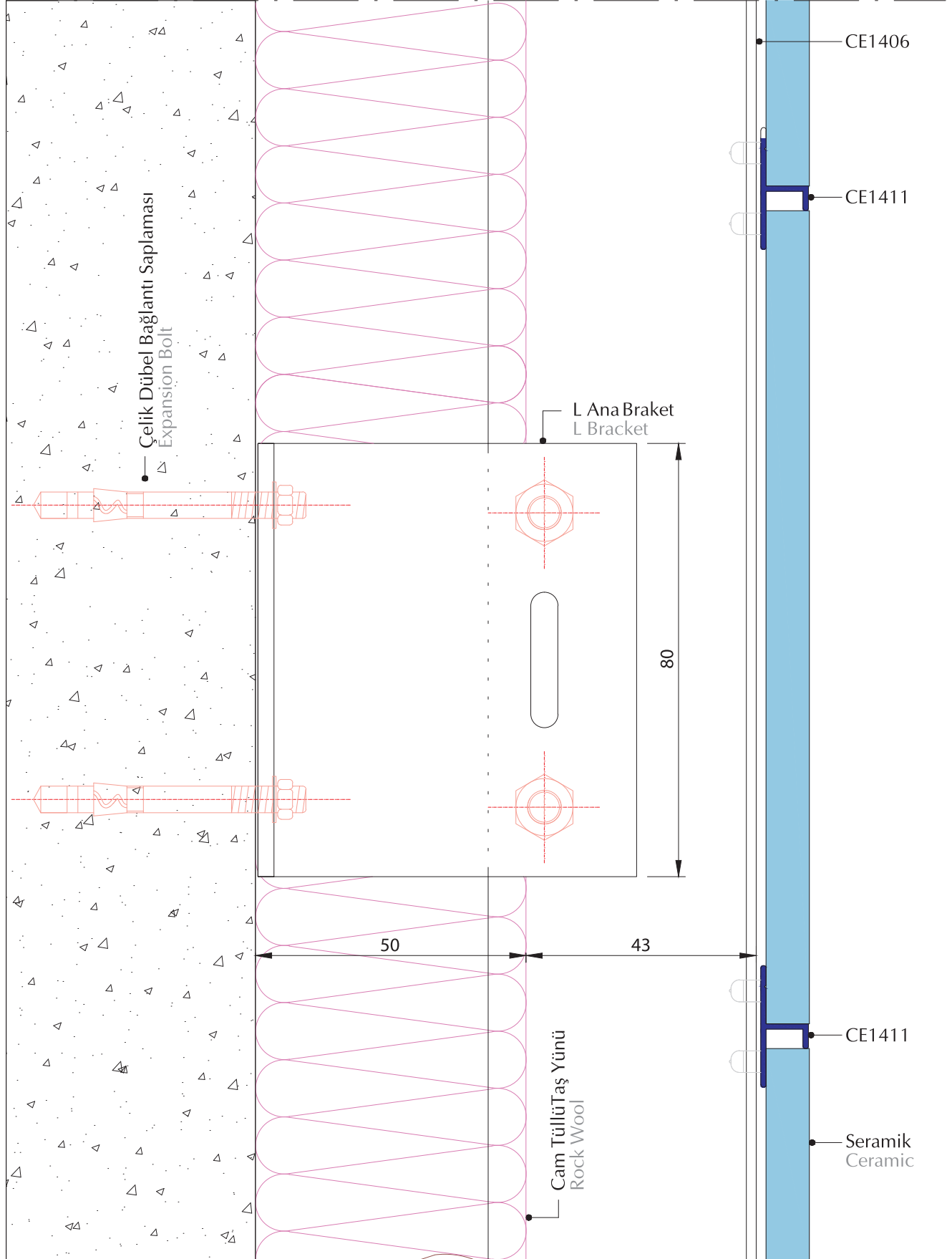

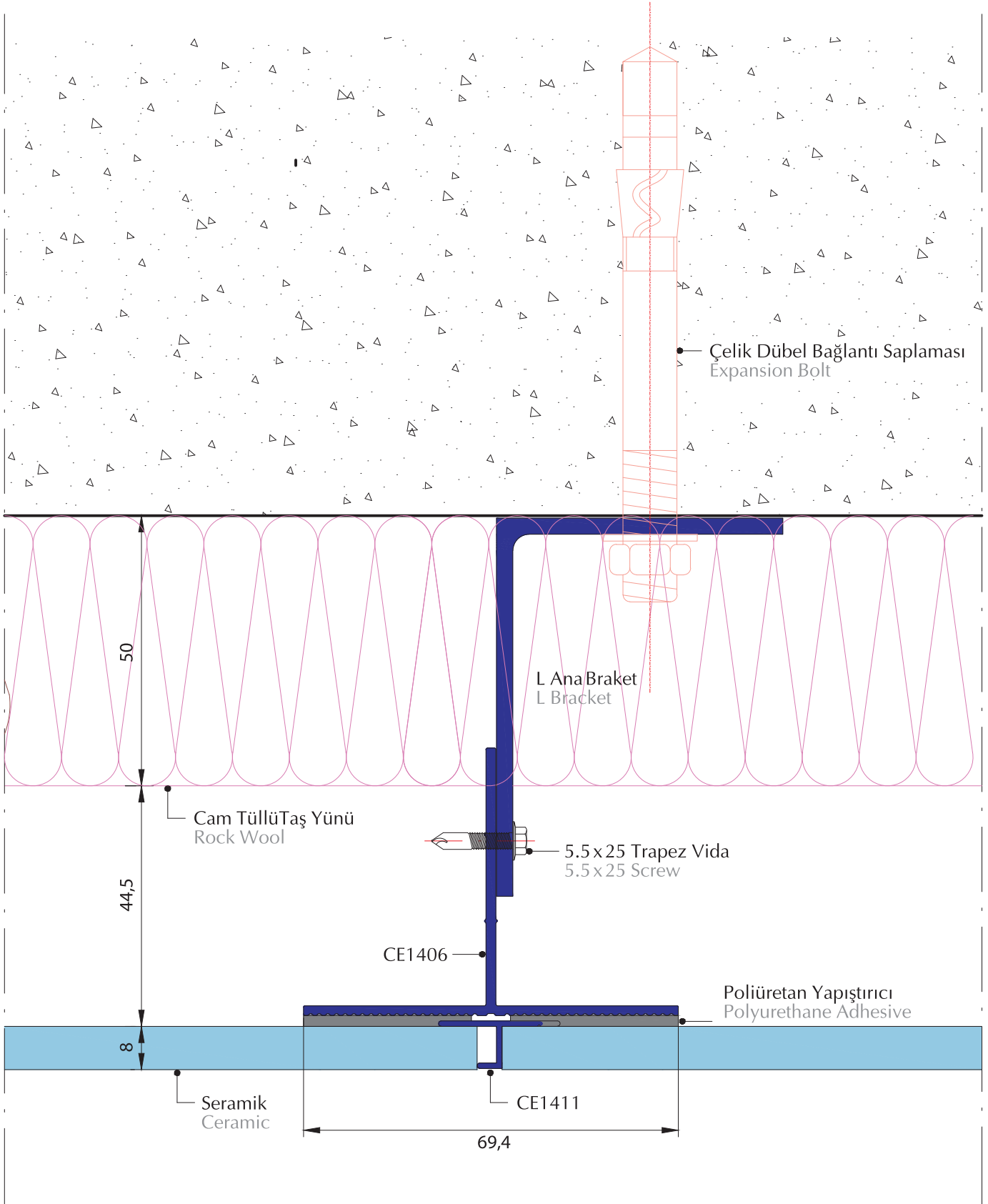

Yapıştırılmalı Sistem Stick System

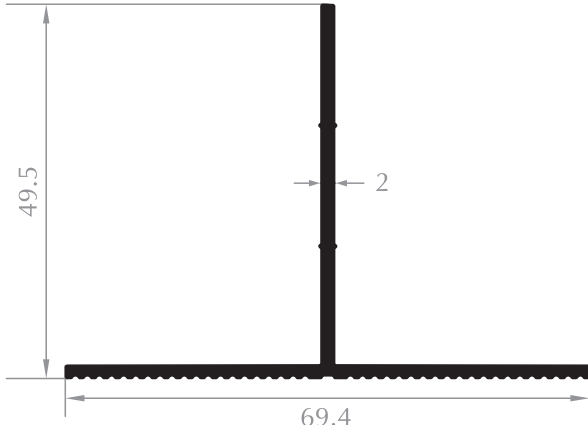

**TIRTIKLİ T  
T PROFILE**

Kod/Code :CE1401  
Ağırlık/Weight:0,618 kg/m

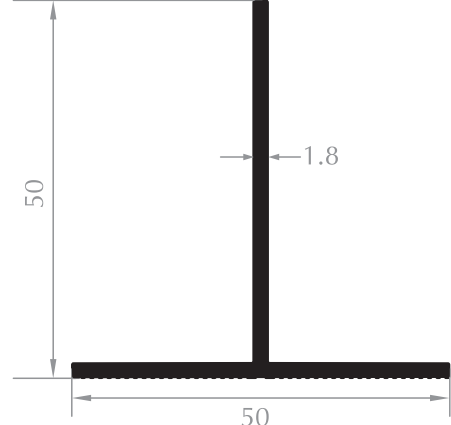

**TIRTIKLİ T  
T PROFILE**

Kod/Code :CE1416  
Ağırlık/Weight:0,507 kg/m

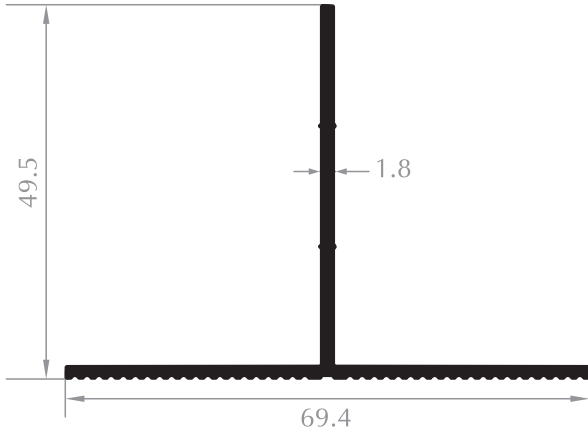

**TIRTIKLİ T  
T PROFILE**

Kod/Code :CE1406  
Ağırlık/Weight:0,545 kg/m

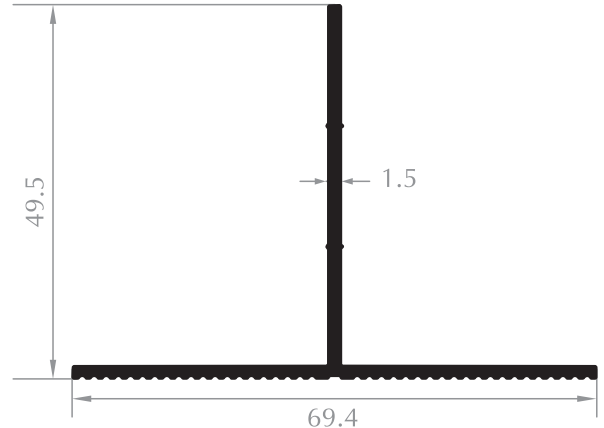

**TIRTIKLİ T  
T PROFILE**

Kod/Code :CE1407  
Ağırlık/Weight:0,451 kg/m

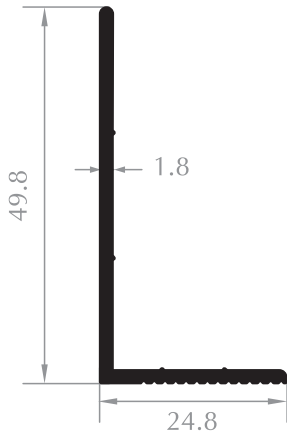

**TIRTIKLİ L  
L PROFILE**

Kod/Code :CE1404  
Ağırlık/Weight:0,350 kg/m

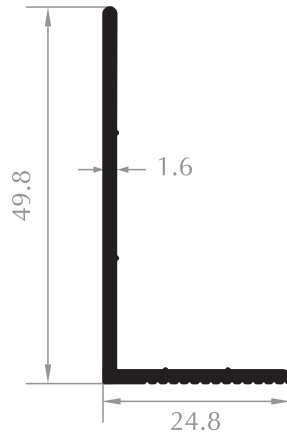

**TIRTIKLİ L  
L PROFILE**

Kod/Code :CE1405  
Ağırlık/Weight:0,312 kg/m

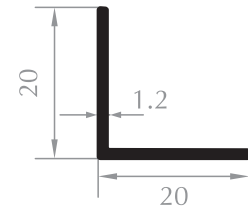

**L PROFİL  
L PROFILE**

Kod/Code :ST2006  
Ağırlık/Weight:0,126 kg/m

Yapıştırırmalı Sistem Stick System

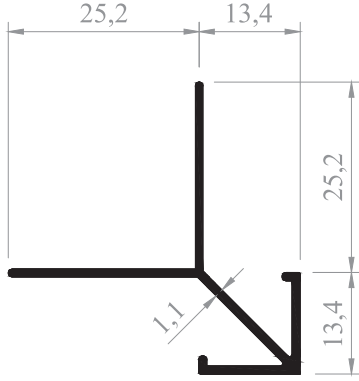

**7'LİK KÖŞE ÇITASI**  
CORNER PROFILE

Kod/Code :CE1408  
Ağırlık/Weight:0,275 kg/m

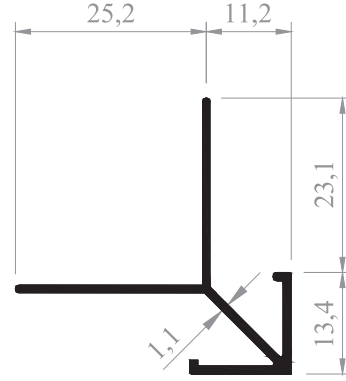

**10'LUK KÖŞE ÇITASI**  
CORNER PROFILE

Kod/Code :CE1409  
Ağırlık/Weight:0,270 kg/m

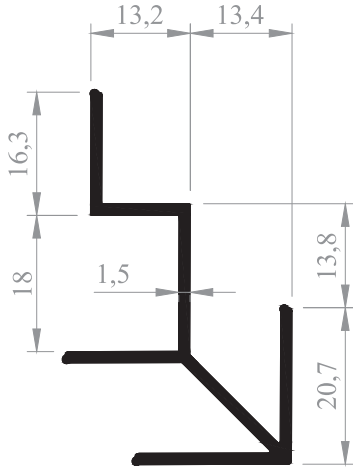

**CEPHE KUYRUKLU KÖŞE**  
CORNER PROFILE

Kod/Code :CE1412  
Ağırlık/Weight:0,482 kg/m

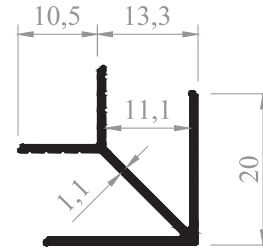

**TAŞ GİRİŞ KÖŞE PROFİLİ**  
CORNER PROFILE

Kod/Code :CE1413  
Ağırlık/Weight:0,225 kg/m

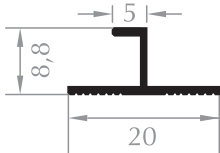

**10'LUK DİKEY DERZ PROFİLİ**  
VERTICAL JOINT PROFILE

Kod/Code :CE1411  
Ağırlık/Weight:0,081 kg/m

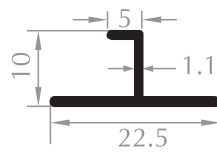

**YATAY DERZ PROFİLİ**  
HORIZONTAL JOINT PROFILE

Kod/Code :CE1410  
Ağırlık/Weight:0,103 kg/m

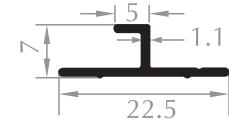

**YATAY DERZ PROFİLİ**  
HORIZONTAL JOINT PROFILE

Kod/Code :CE1403  
Ağırlık/Weight:0,095 kg/m

Zikov Kanallı Sistem Montaj Detayı  
Zikov System Application Details

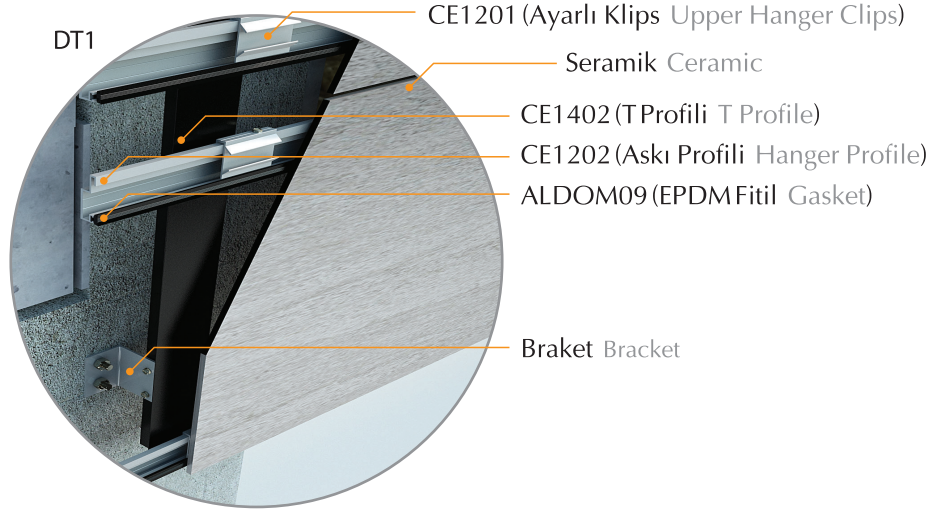

Zikov Kanallı Sistem Montaj Detayı  
Zikov System Application Details

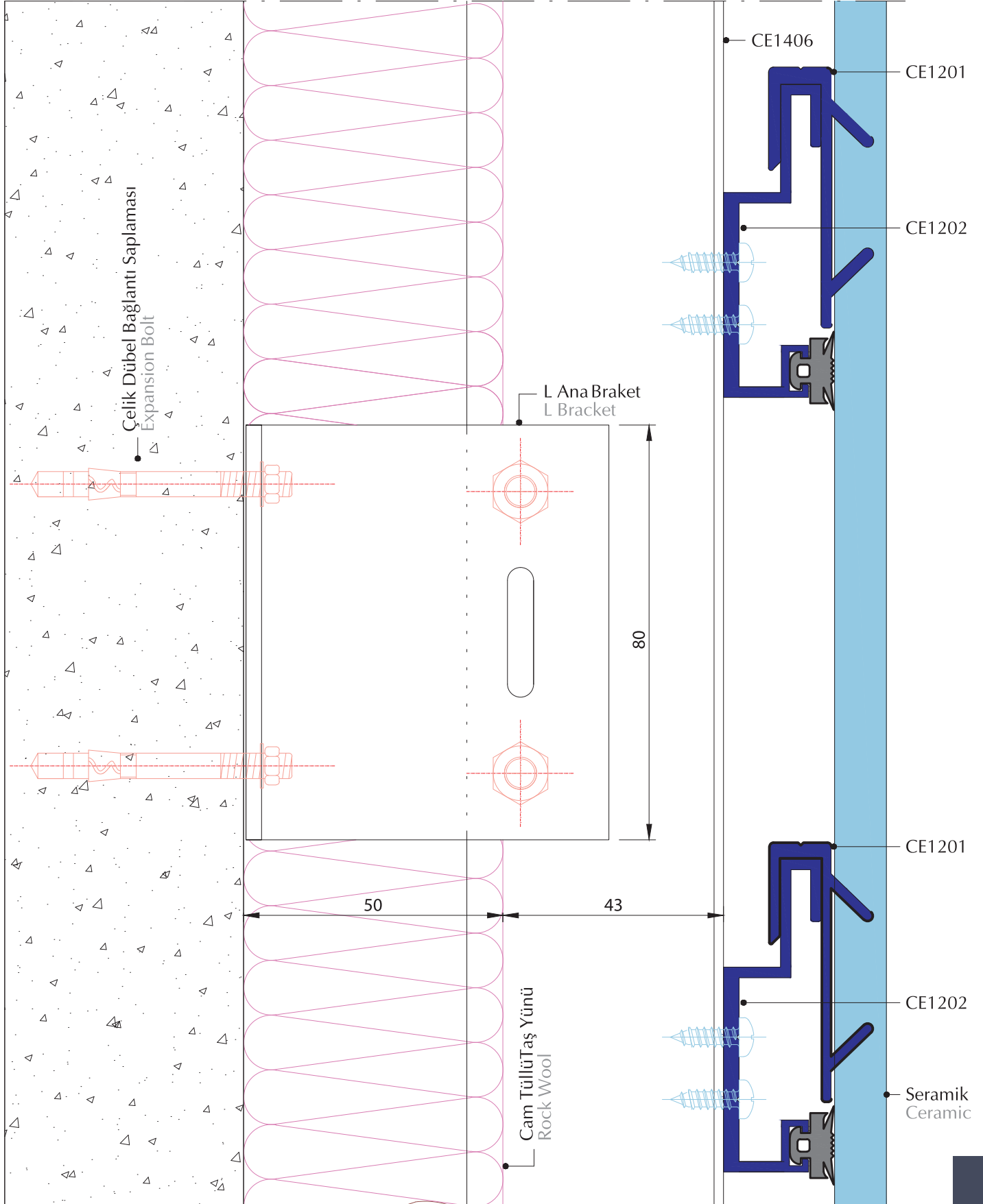

Zikov Kanallı Sistem Zikov System

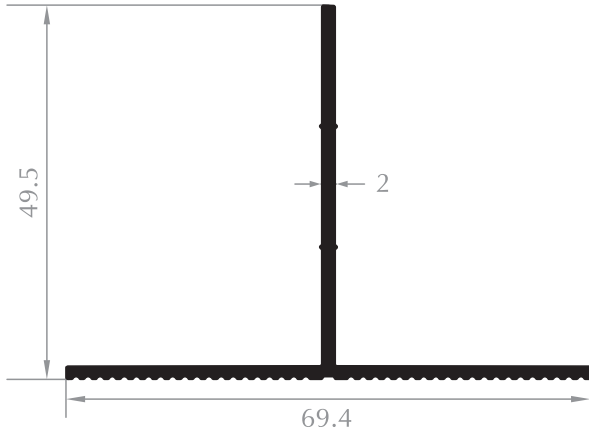

**TIRTIKLİ T  
T PROFILE**

Kod/Code :CE1401  
Ağırlık/Weight:0,618 kg/m

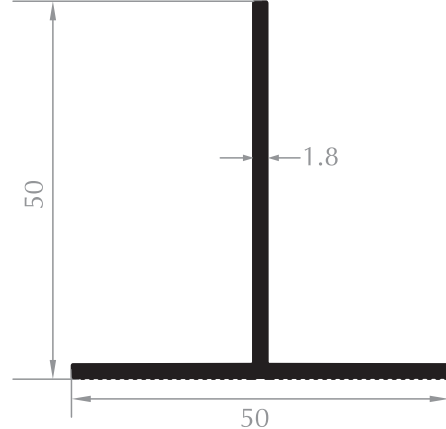

**TIRTIKLİ T  
T PROFILE**

Kod/Code :CE1416  
Ağırlık/Weight:0,507 kg/m

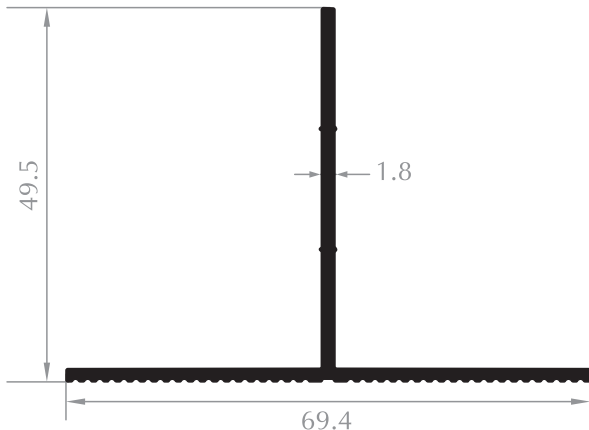

**TIRTIKLİ T  
T PROFILE**

Kod/Code :CE1406  
Ağırlık/Weight:0,545 kg/m

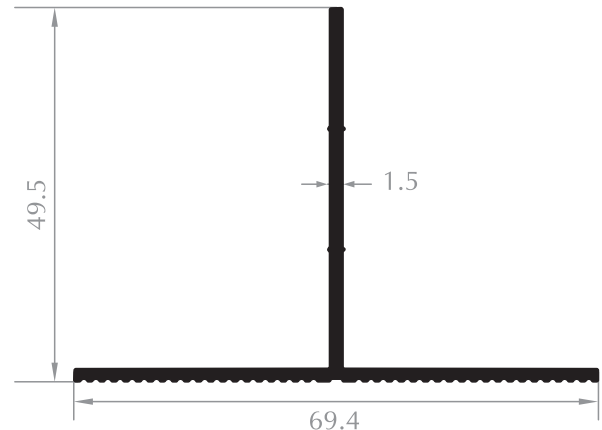

**TIRTIKLİ T  
T PROFILE**

Kod/Code :CE1407  
Ağırlık/Weight:0,451 kg/m

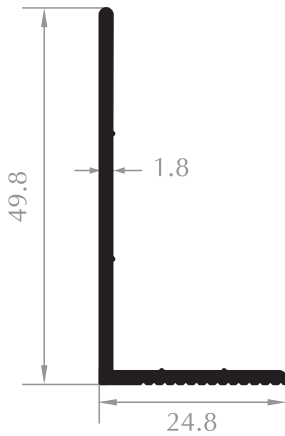

**TIRTIKLİ L  
L PROFILE**

Kod/Code :CE1404  
Ağırlık/Weight:0,350 kg/m

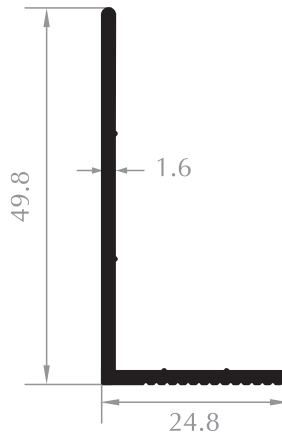

**TIRTIKLİ L  
L PROFILE**

Kod/Code :CE1405  
Ağırlık/Weight:0,312 kg/m

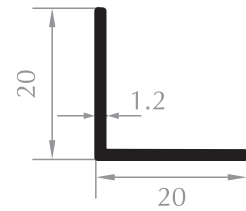

**L PROFİL  
L PROFILE**

Kod/Code :ST2006  
Ağırlık/Weight:0,126 kg/m

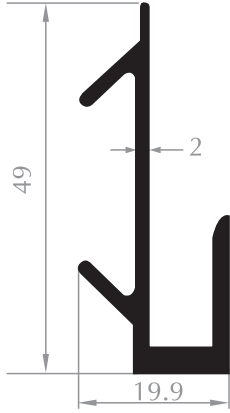

**AYARLI KLİPS**  
CLIPS

Kod/Code :CE1201  
Ağırlık/Weight:0,553 kg/m



**ASKI PROFİLİ**  
HANGER PROFILE

Kod/Code :CE1202  
Ağırlık/Weight:0,560 kg/m

Poliüretan Askılı Sistem Montaj Detayı  
Polyurethane Suspended System Application Details

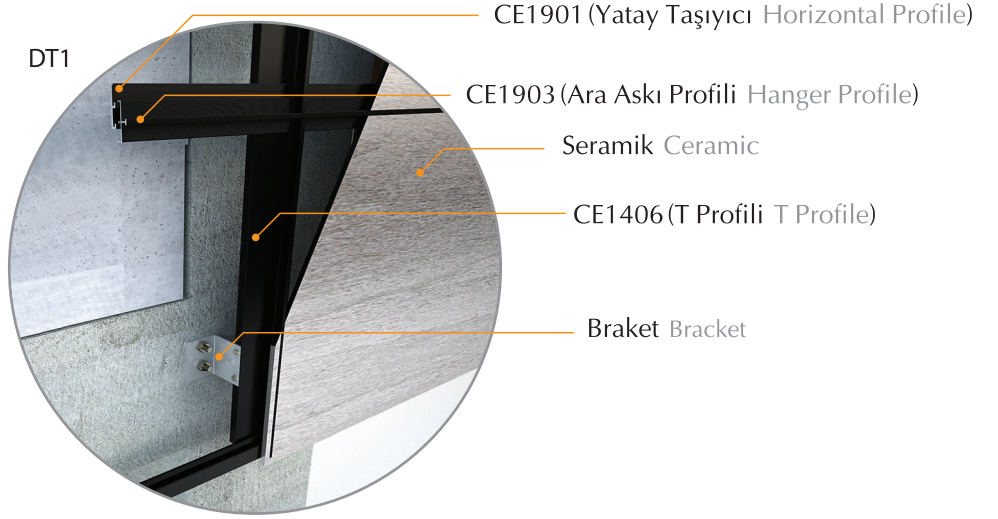

Poliüretan Askılı Sistem Montaj Detayı  
Polyurethane Suspended System Application Details

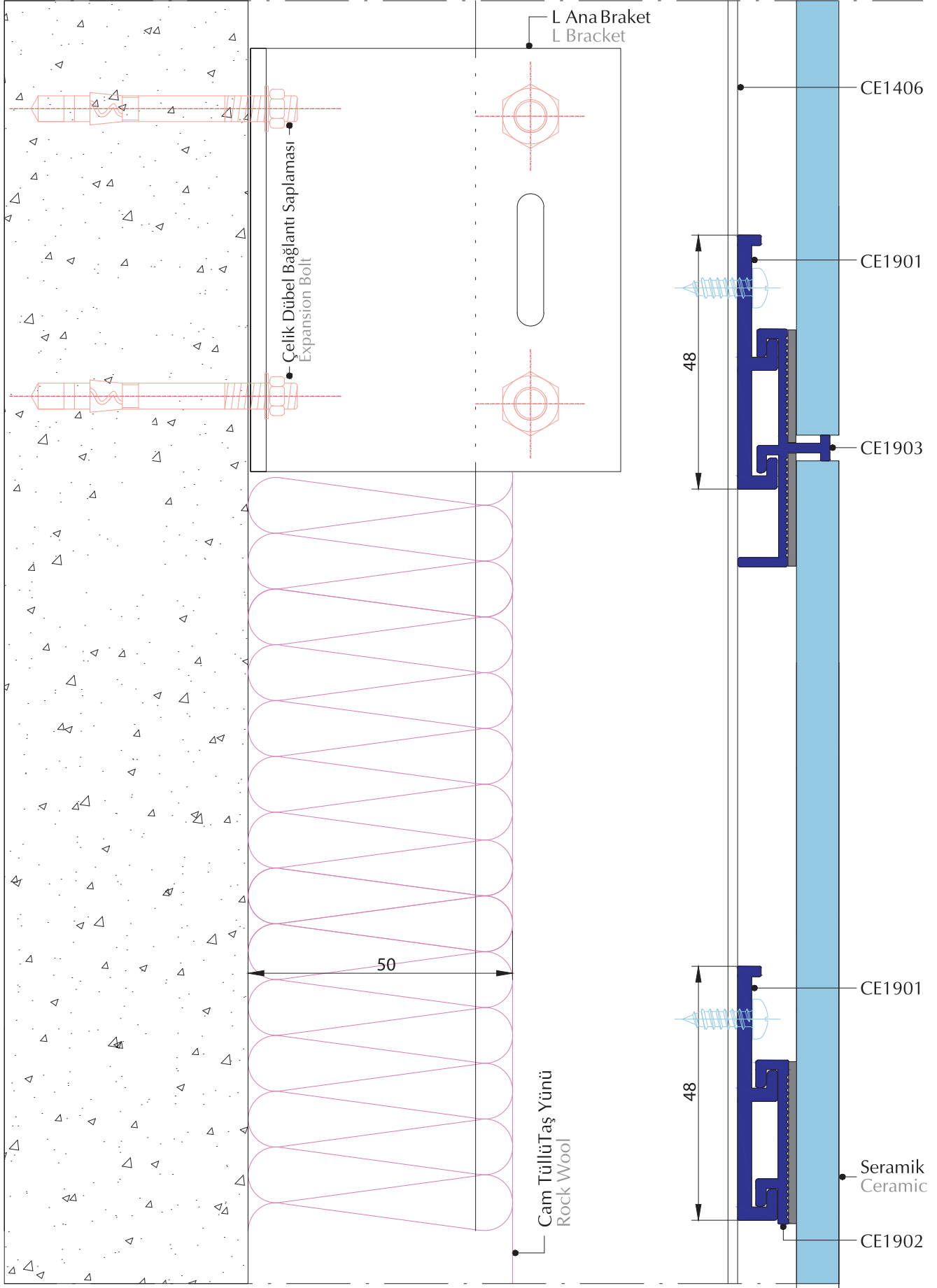

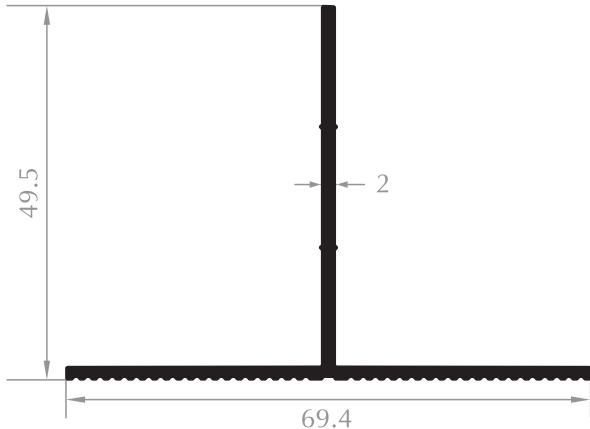

**TIRTIKLİ T  
T PROFILE**  
Kod/Code :CE1401  
Ağırlık/Weight:0,618 kg/m

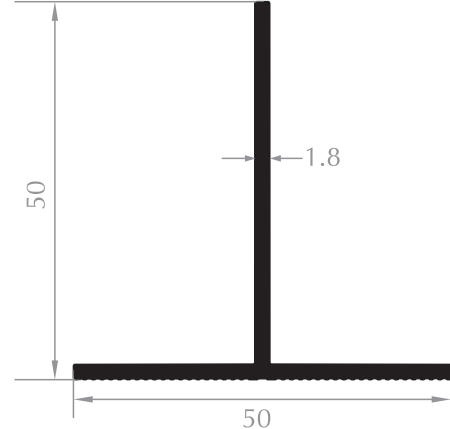

**TIRTIKLİ T  
T PROFILE**  
Kod/Code :CE1416  
Ağırlık/Weight:0,507 kg/m

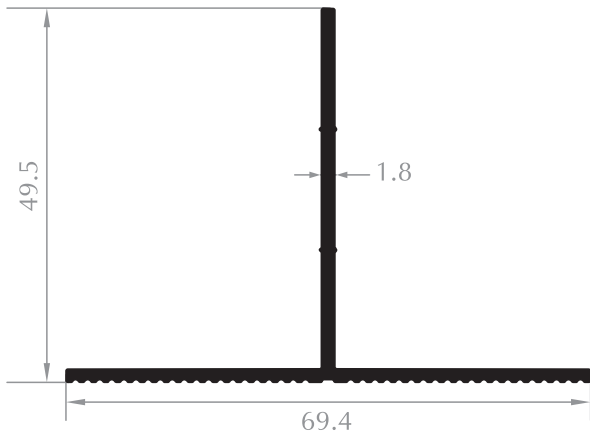

**TIRTIKLİ T  
T PROFILE**  
Kod/Code :CE1406  
Ağırlık/Weight:0,545 kg/m

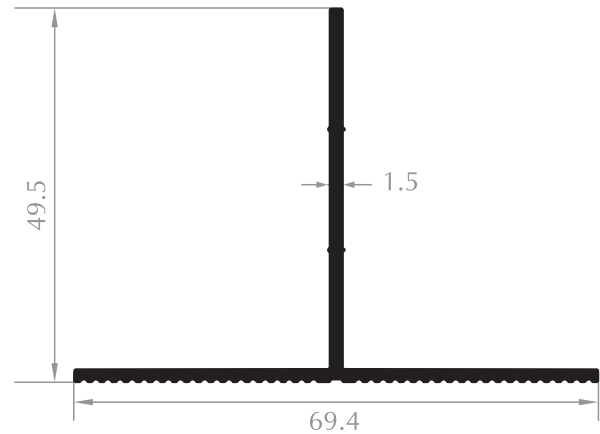

**TIRTIKLİ T  
T PROFILE**  
Kod/Code :CE1407  
Ağırlık/Weight:0,451 kg/m

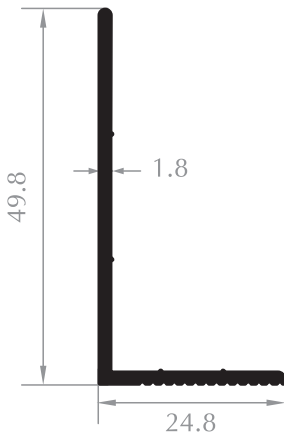

**TIRTIKLİ L  
L PROFILE**  
Kod/Code :CE1404  
Ağırlık/Weight:0,350 kg/m

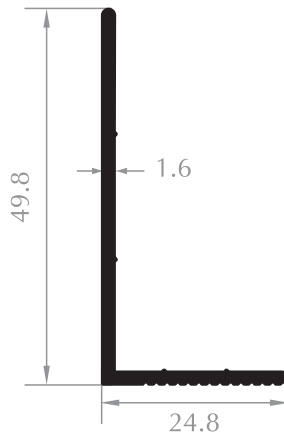

**TIRTIKLİ L  
L PROFILE**  
Kod/Code :CE1405  
Ağırlık/Weight:0,312 kg/m

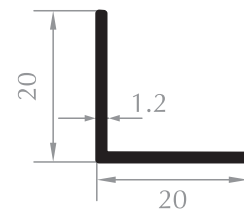

**L PROFİL  
L PROFILE**  
Kod/Code :ST2006  
Ağırlık/Weight:0,126 kg/m



**YATAY TAŞIYICI**  
HORIZONTAL PROFILE  
Kod/Code : CE1901  
Ağırlık/Weight : 0,460 kg/m

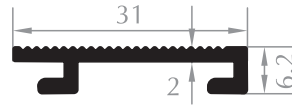

**BAŞLANGIÇ ve BİTİŞ PROFİLİ**  
STARTING and FINISHING PROFILE  
Kod/Code : CE1902  
Ağırlık/Weight : 0,230 kg/m

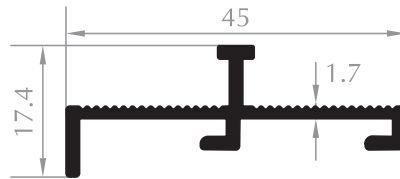

**ARA ASKI PROFİLİ**  
HANGER PROFILE  
Kod/Code : CE1903  
Ağırlık/Weight : 0,351 kg/m

Montaj Detayı Application Details

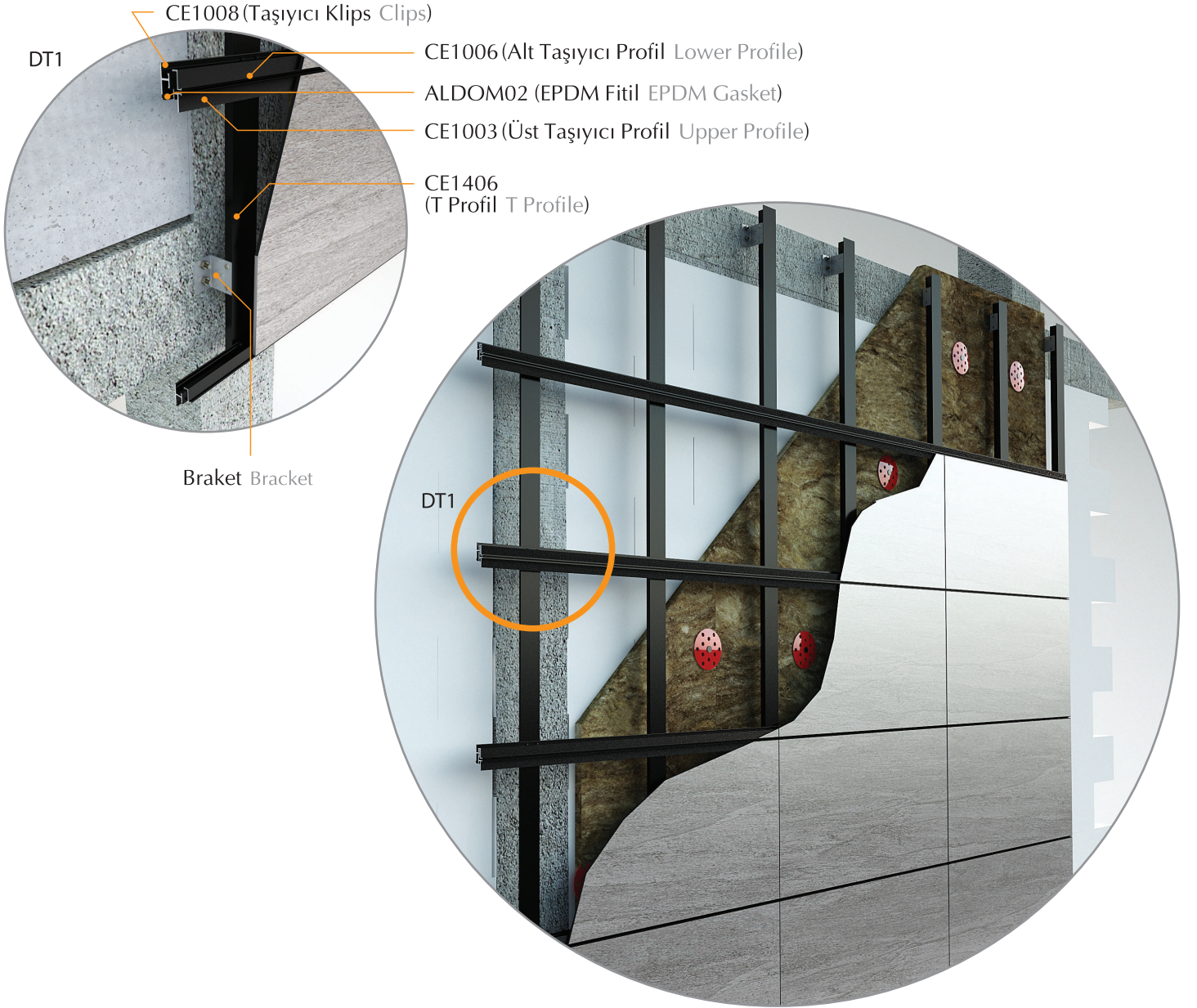

Aksesuarlar  
Accessories



C CONTA  
GASKET

Kod/Code :ALDOM-03



KLIPS CONTASI  
GASKET

Kod/Code :ALDOM-02

Montaj Detayı Application Details

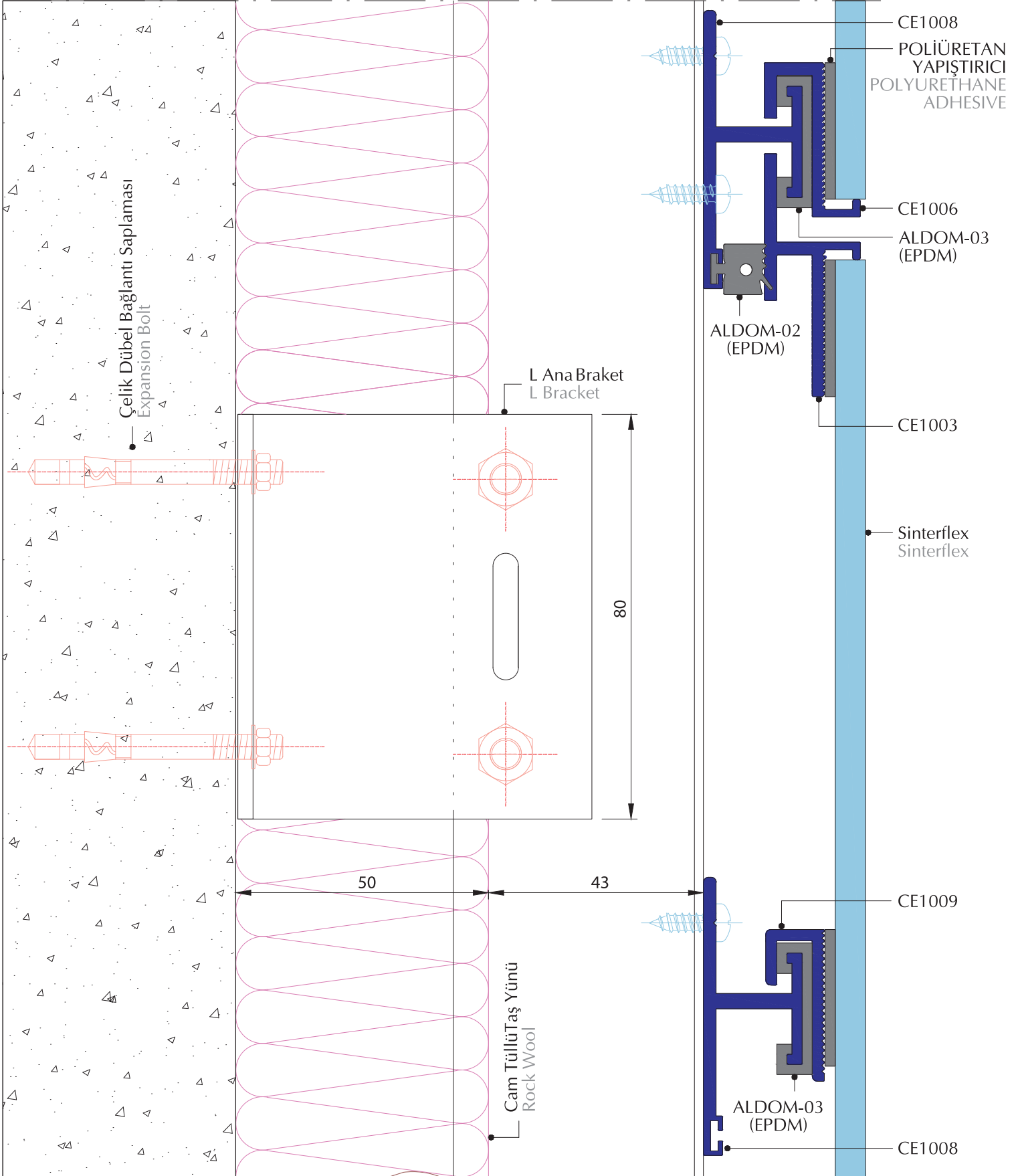

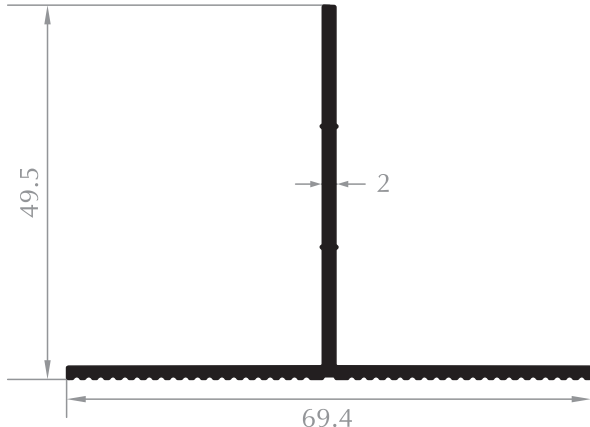

**TIRTIKLİ T  
T PROFILE**  
Kod/Code :CE1401  
Ağırlık/Weight:0,618 kg/m

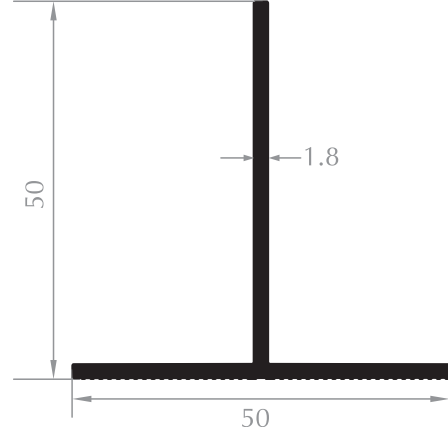

**TIRTIKLİ T  
T PROFILE**  
Kod/Code :CE1416  
Ağırlık/Weight:0,507 kg/m

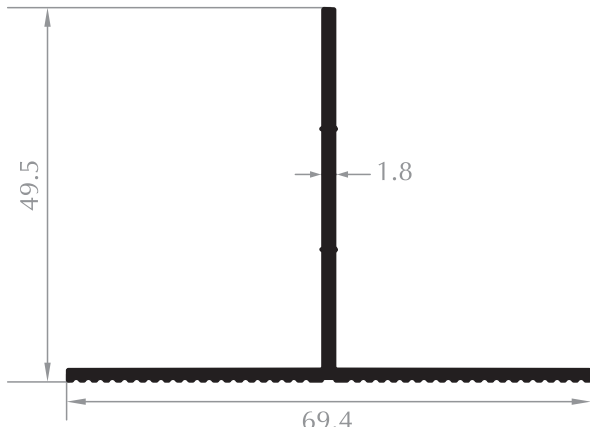

**TIRTIKLİ T  
T PROFILE**  
Kod/Code :CE1406  
Ağırlık/Weight:0,545 kg/m

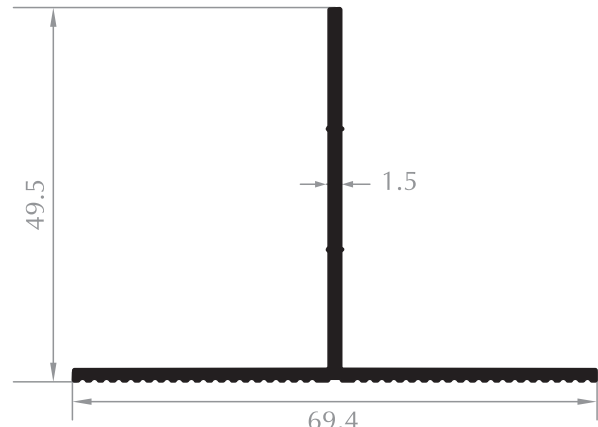

**TIRTIKLİ T  
T PROFILE**  
Kod/Code :CE1407  
Ağırlık/Weight:0,451 kg/m

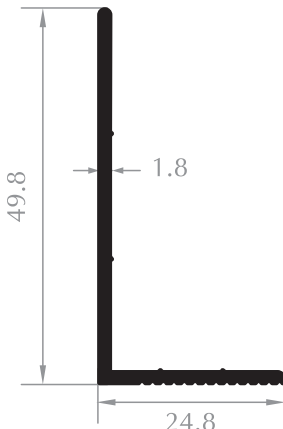

**TIRTIKLİ L  
L PROFILE**  
Kod/Code :CE1404  
Ağırlık/Weight:0,350 kg/m

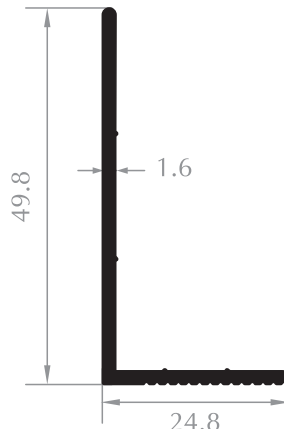

**TIRTIKLİ L  
L PROFILE**  
Kod/Code :CE1405  
Ağırlık/Weight:0,312 kg/m

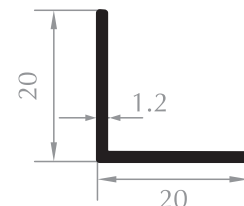

**L PROFİL  
L PROFILE**  
Kod/Code :ST2006  
Ağırlık/Weight:0,126 kg/m

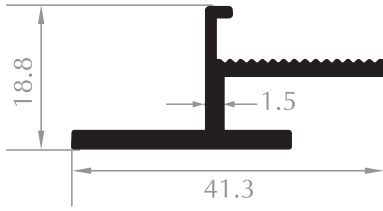

**ÜST TAŞIYICI PROFİL**  
UPPER PROFILE  
Kod/Code :CE1001  
Ağırlık/Weight:0,396 kg/m

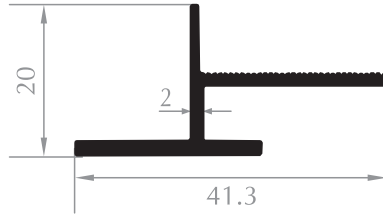

**ÜST TAŞIYICI PROFİL**  
UPPER PROFILE  
Kod/Code :CE1002  
Ağırlık/Weight:0,377 kg/m

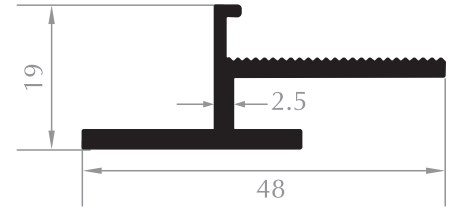

**ÜST TAŞIYICI PROFİL**  
UPPER PROFILE  
Kod/Code :CE1003  
Ağırlık/Weight:0,470 kg/m

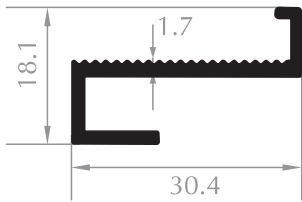

**ALT TAŞIYICI PROFİL**  
LOWER PROFILE  
Kod/Code :CE1004  
Ağırlık/Weight:0,283 kg/m

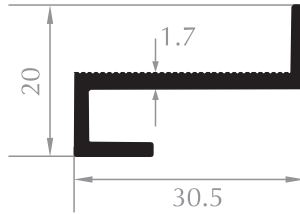

**ALT TAŞIYICI PROFİL**  
LOWER PROFILE  
Kod/Code :CE1005  
Ağırlık/Weight:0,264 kg/m

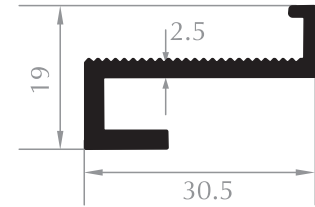

**ALT TAŞIYICI PROFİL**  
LOWER PROFILE  
Kod/Code :CE1006  
Ağırlık/Weight:0,349 kg/m

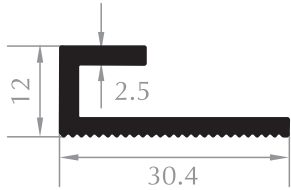

**ORTA ASKI PROFİL DÜZ**  
MIDDLE HANGER PROFILE  
Kod/Code :CE1010  
Ağırlık/Weight:0,315 kg/m

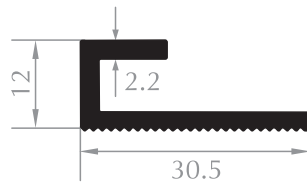

**ORTA ASKI PROFİL DÜZ**  
MIDDLE HANGER PROFILE  
Kod/Code :CE1009  
Ağırlık/Weight:0,284 kg/m

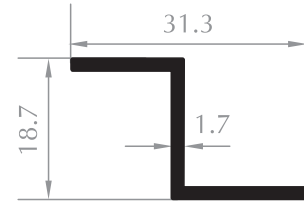

**Z PROFİLİ**  
Z PROFILE  
Kod/Code :CE2507  
Ağırlık/Weight:0,222 kg/m

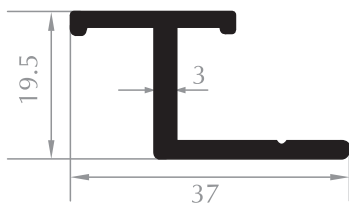

**KLİPS**  
CLIPS  
Kod/Code :CE1007  
Ağırlık/Weight:0,425 kg/m

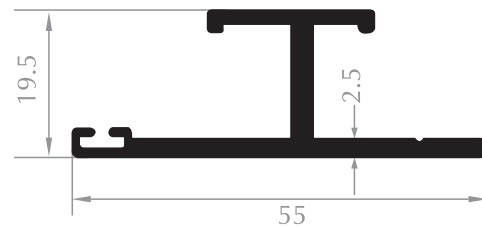

**TAŞIYICI KLİPS**  
CLIPS  
Kod/Code :CE1008  
Ağırlık/Weight:0,620 kg/m

Montaj Detayı Application Details

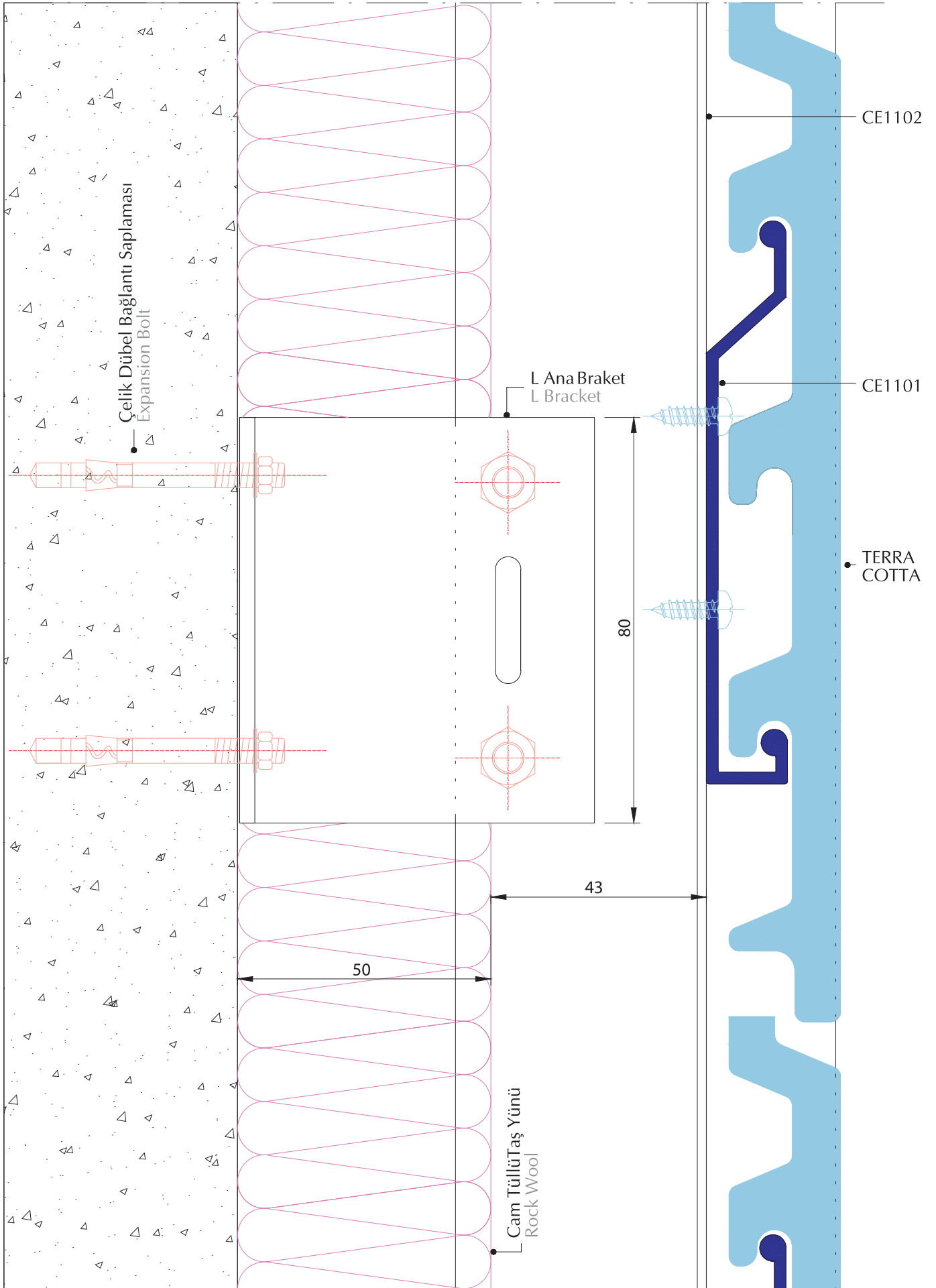

Montaj Detayı Application Details

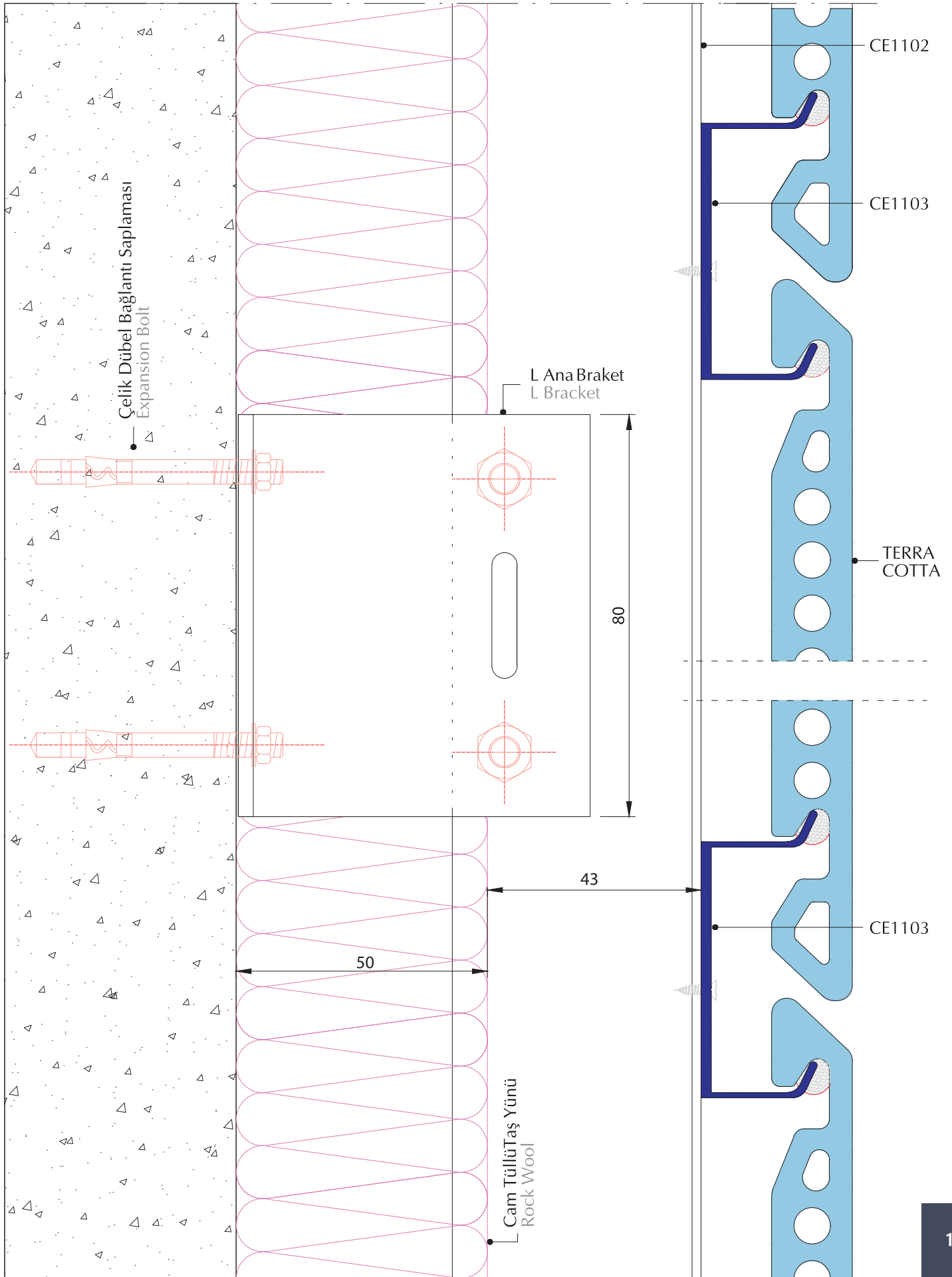

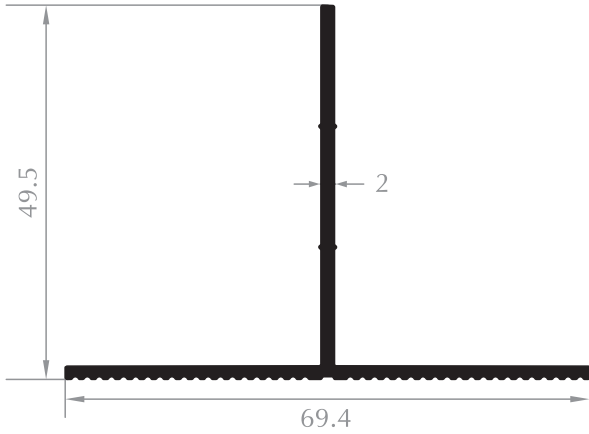

**TIRTIKLİ T**  
**T PROFILE**  
Kod/Code :CE1401  
Ağırlık/Weight:0,618 kg/m

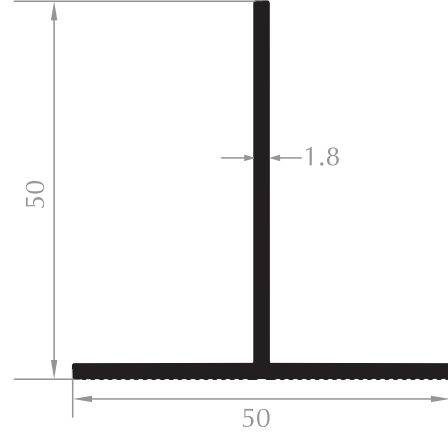

**TIRTIKLİ T**  
**T PROFILE**  
Kod/Code :CE1416  
Ağırlık/Weight:0,507 kg/m

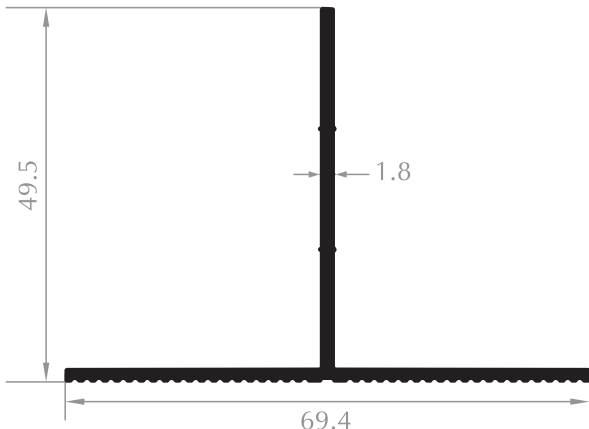

**TIRTIKLİ T**  
**T PROFILE**  
Kod/Code :CE1406  
Ağırlık/Weight:0,545 kg/m

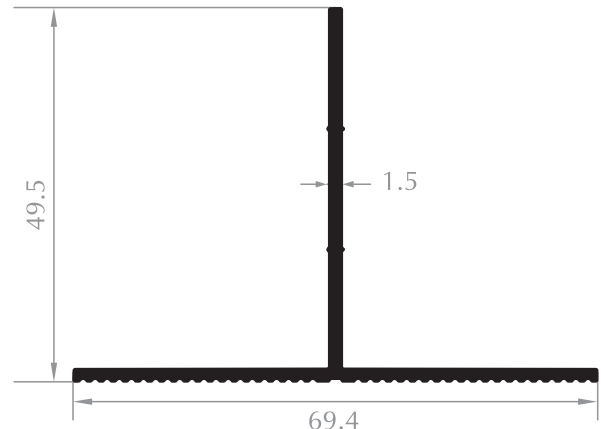

**TIRTIKLİ T**  
**T PROFILE**  
Kod/Code :CE1407  
Ağırlık/Weight:0,451 kg/m

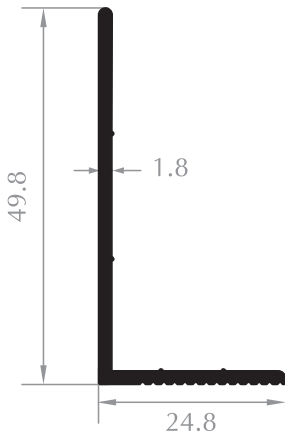

**TIRTIKLİ L**  
**L PROFILE**  
Kod/Code :CE1404  
Ağırlık/Weight:0,350 kg/m

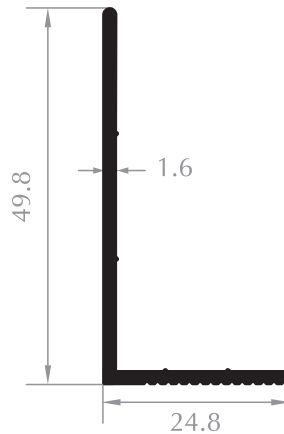

**TIRTIKLİ L**  
**L PROFILE**  
Kod/Code :CE1405  
Ağırlık/Weight:0,312 kg/m

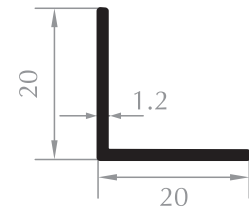

**L PROFİL**  
**L PROFILE**  
Kod/Code :ST2006  
Ağırlık/Weight:0,126 kg/m



**ASKI PROFİLİ**  
**HANGER PROFILE**  
Kod/Code :CE1101  
Ağırlık/Weight:0,921 kg/m

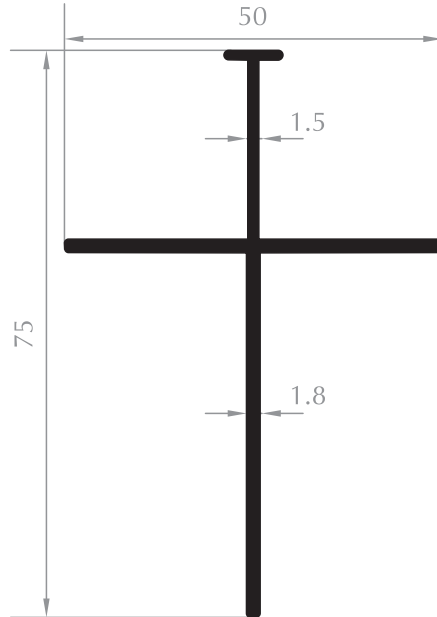

**T PROFİLİ**  
**T PROFILE**  
Kod/Code :CE1102  
Ağırlık/Weight:0,602 kg/m

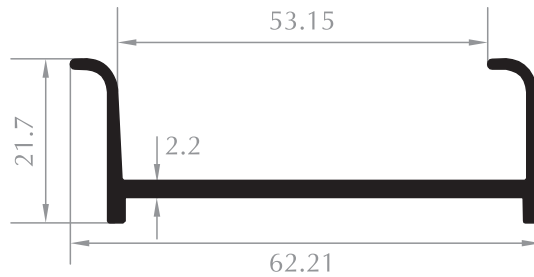

**ASKI PROFİLİ**  
**HANGER PROFILE**  
Kod/Code :CE1103  
Ağırlık/Weight:0,582 kg/m

Montaj Detayı Application Details

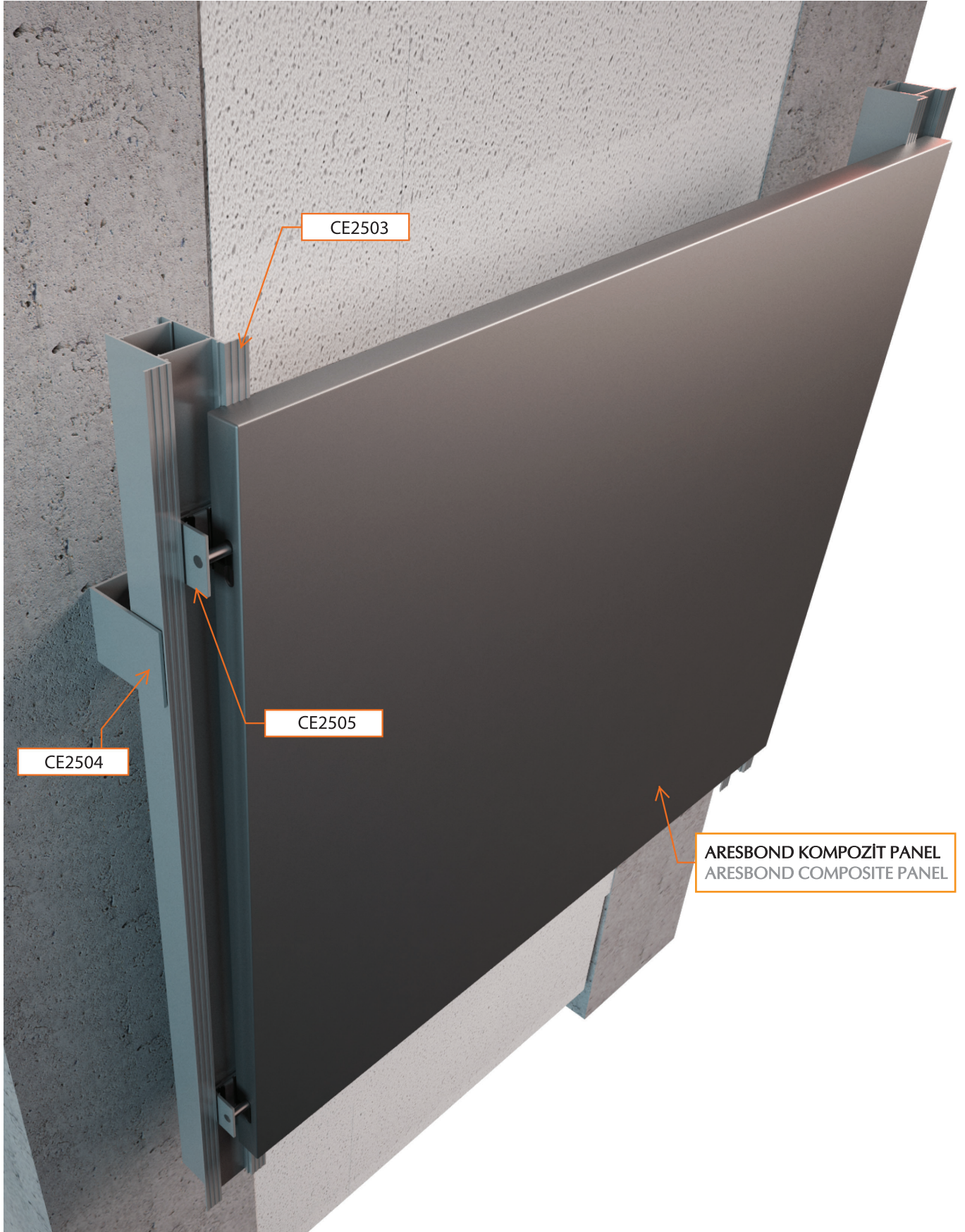

Montaj Detayı Application Details

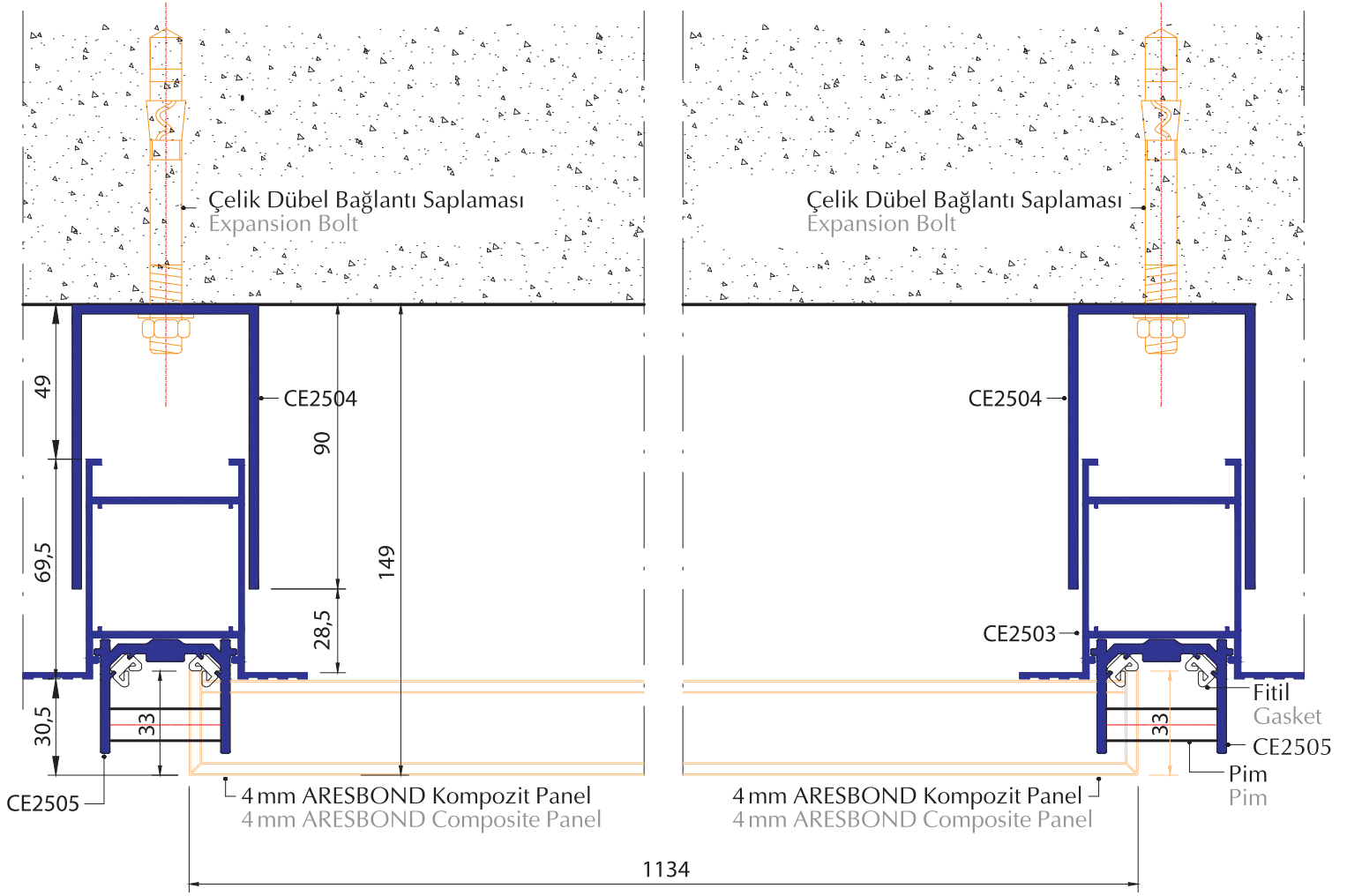

PLAN

Montaj Detayı Application Details

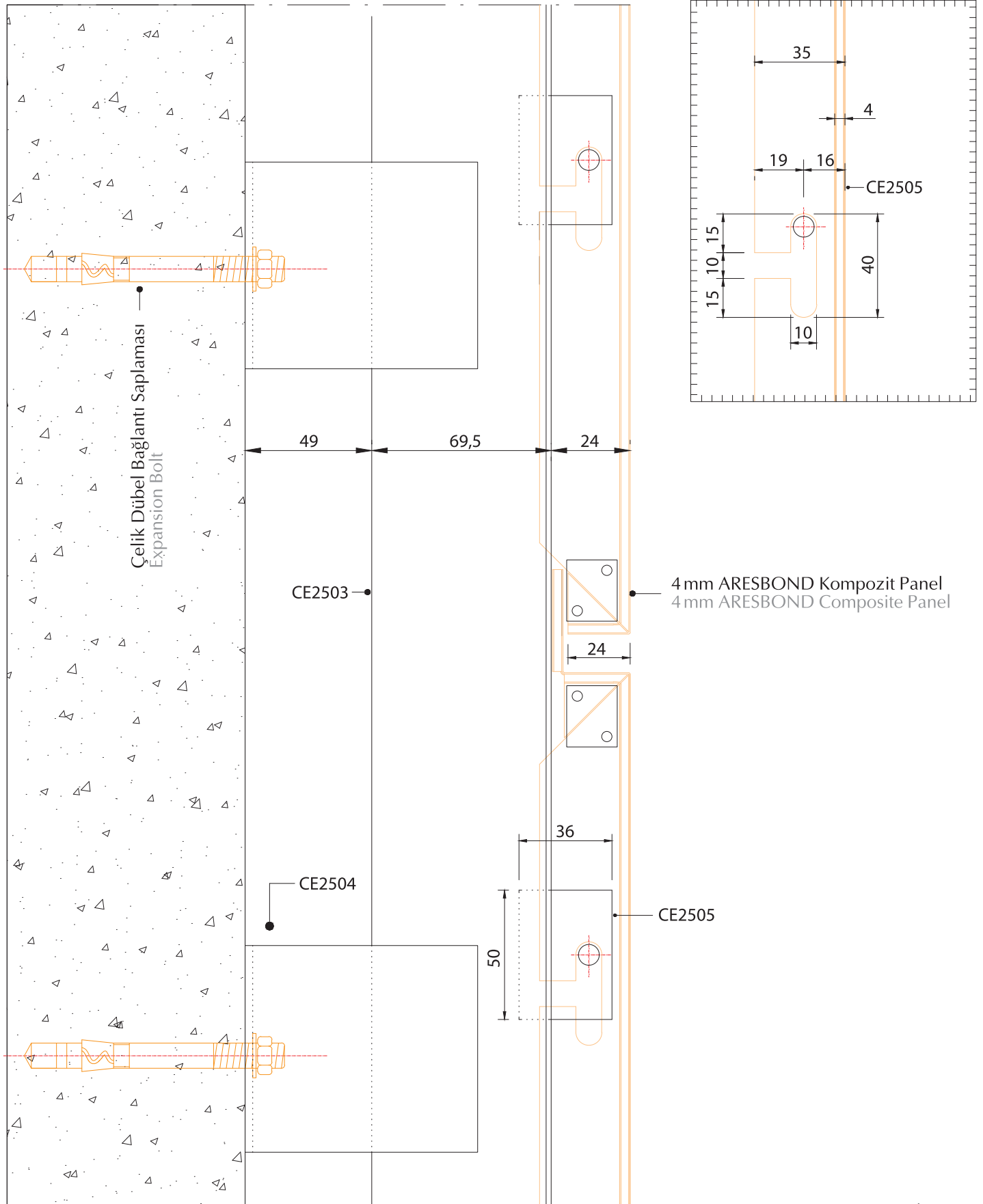

KESİT

Montaj Detayı Application Details

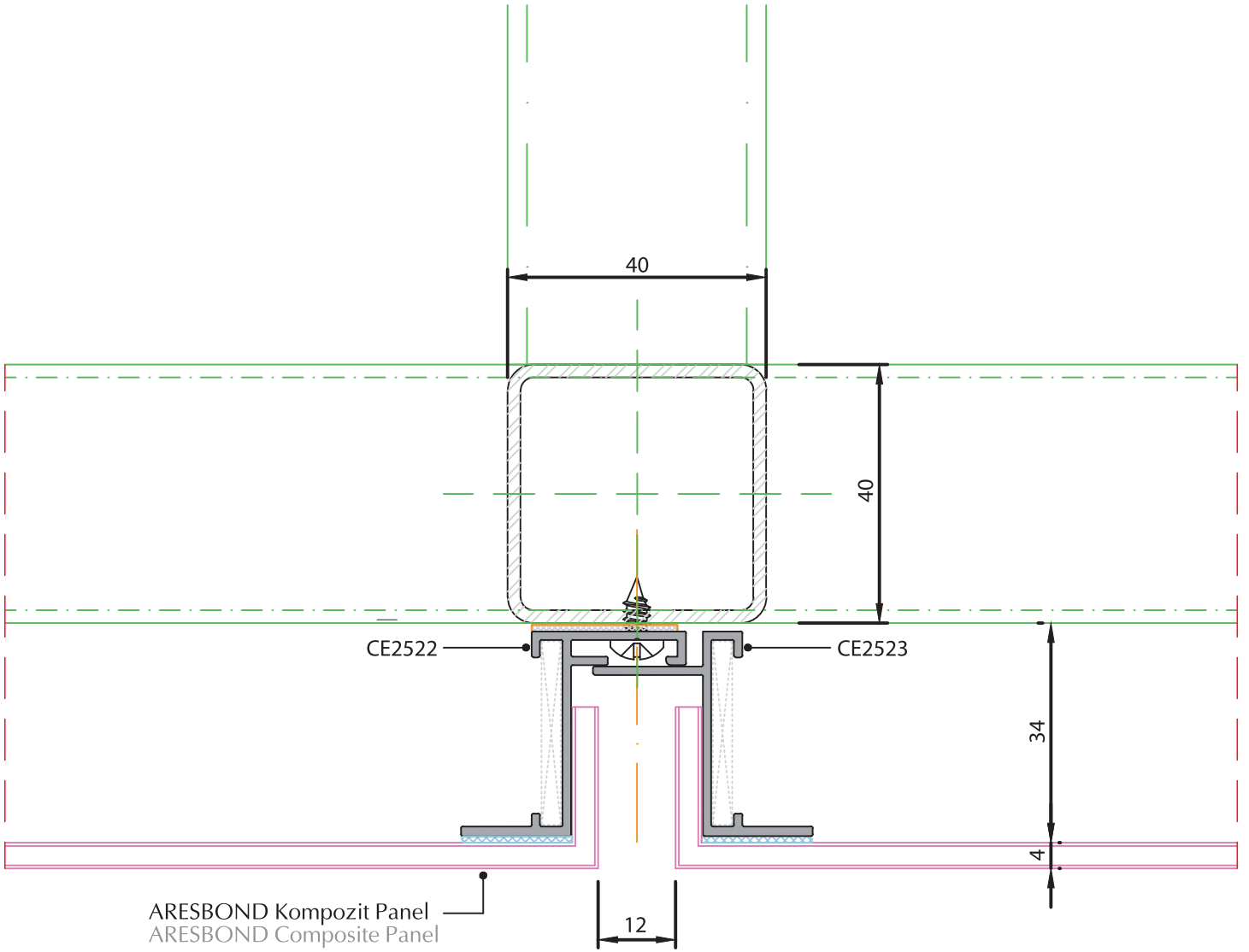

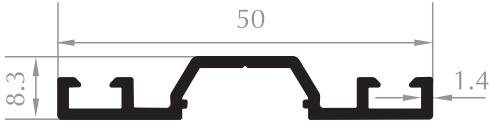

**KOMPOZİT BASKI PROFİLİ**  
COMPOSITE CAP PROFILE  
Kod/Code :CE2509  
Ağırlık/Weight :0,306 kg/m

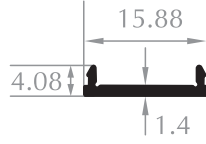

**KOMPOZİT BASKI KAPAĞI**  
COMPOSITE CAP PROFILE  
Kod/Code :CE2510  
Ağırlık/Weight :0,076 kg/m

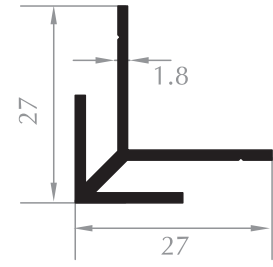

**KÖŞE PROFİLİ**  
CORNER PROFILE  
Kod/Code :CE2508  
Ağırlık/Weight :0,283 kg/m

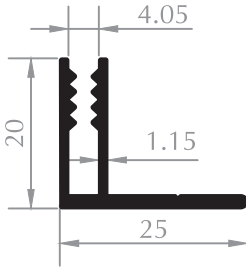

**F PROFİLİ**  
F PROFILE  
Kod/Code :CE2524  
Ağırlık/Weight :0,258 kg/m

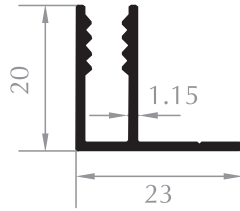

**F PROFİLİ**  
F PROFILE  
Kod/Code :CE2512  
Ağırlık/Weight :0,211 kg/m

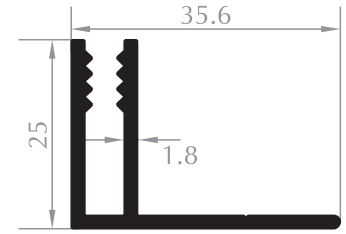

**F PROFİLİ**  
F PROFILE  
Kod/Code :CE2518  
Ağırlık/Weight :0,423 kg/m

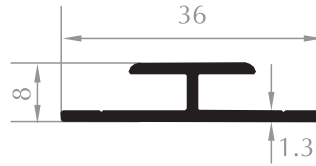

**H PROFİLİ**  
H PROFILE  
Kod/Code :CE2511  
Ağırlık/Weight :0,225 kg/m

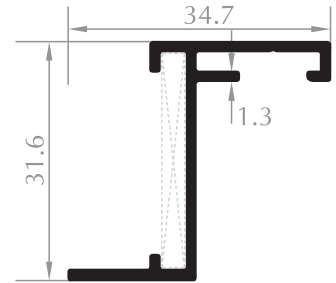

**KASET PROFİLİ**  
SASH PROFILE  
Kod/Code :CE2522  
Ağırlık/Weight :0,311 kg/m

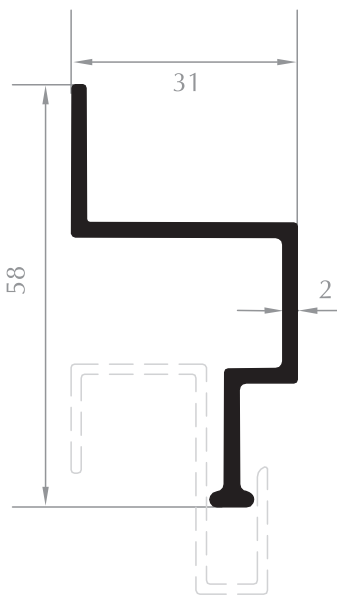

**ASKI PROFİLİ**  
HANGER PROFILE  
Kod/Code :CE2502  
Ağırlık/Weight :0,536 kg/m

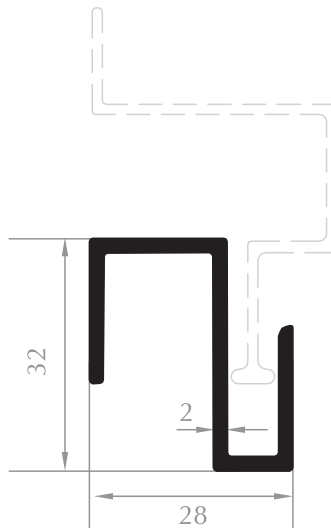

**ASKI PROFİLİ**  
HANGER PROFILE  
Kod/Code :CE2501  
Ağırlık/Weight :0,508 kg/m

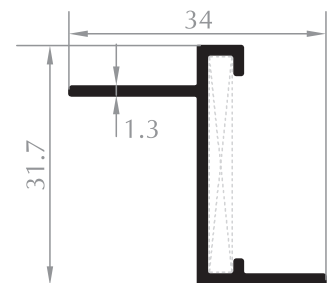

**KOMPOZİT ASKI**  
COMPOSITE HANGER PROFILE  
Kod/Code :CE2523  
Ağırlık/Weight :0,269 kg/m

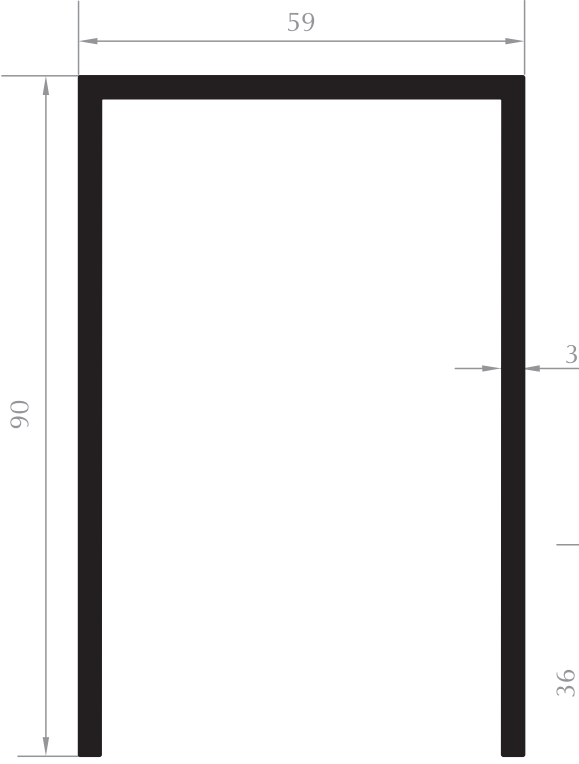

**KOMPOZİT U PROFİLİ**  
COMPOSITE U PROFILE  
Kod/Code : CE2504  
Ağırlık/Weight: 1,895 kg/m

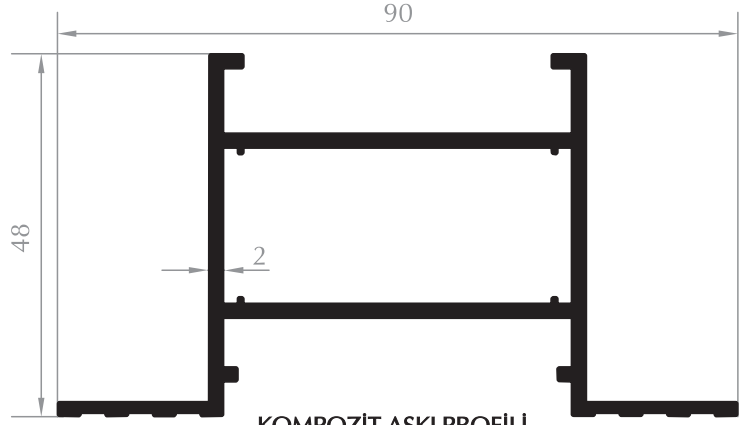

**KOMPOZİT ASKI PROFİLİ**  
COMPOSITE HANGER PROFILE  
Kod/Code : CE2506  
Ağırlık/Weight: 1,271 kg/m

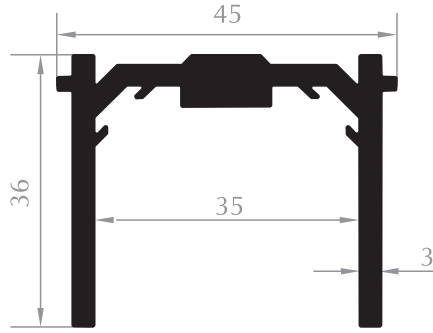

**KOMPOZİT BAĞLANTI PROFİLİ**  
COMPOSITE CONNECTION PROFILE  
Kod/Code : CE2505  
Ağırlık/Weight: 1,056 kg/m

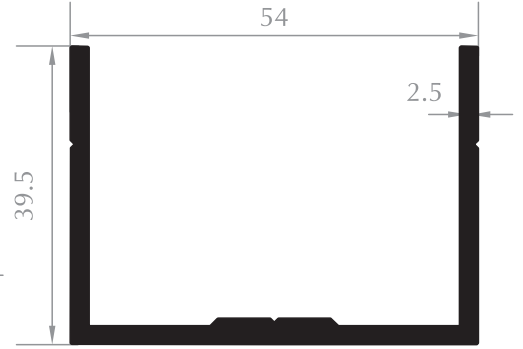

**KOMPOZİT BAĞLANTI PROFİLİ**  
COMPOSITE CONNECTION PROFILE  
Kod/Code : CE4022  
Ağırlık/Weight: 0,908 kg/m

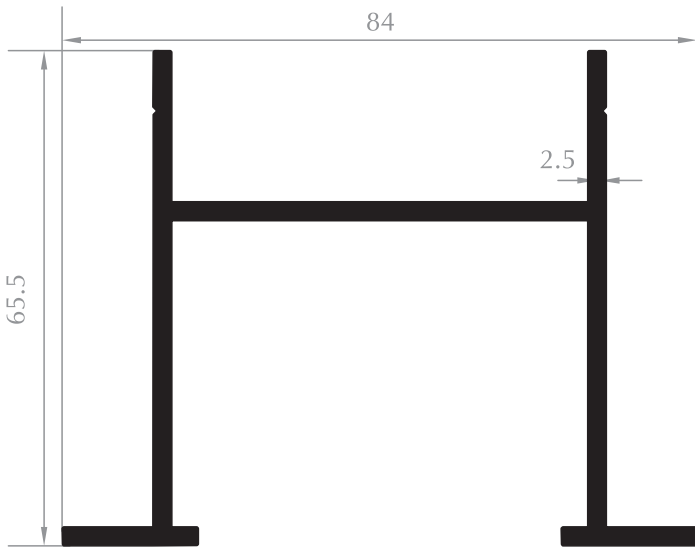

**KOMPOZİT ASKI PROFİLİ**  
COMPOSITE HANGER PROFILE  
Kod/Code : CE4023  
Ağırlık/Weight: 1,468 kg/m

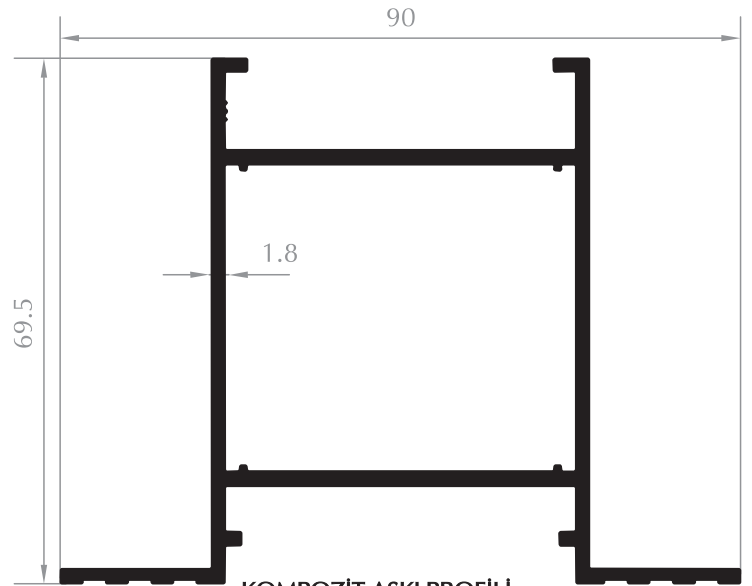

**KOMPOZİT ASKI PROFİLİ**  
COMPOSITE HANGER PROFILE  
Kod/Code : CE2503  
Ağırlık/Weight: 1,434 kg/m

Montaj Detayı Application Details

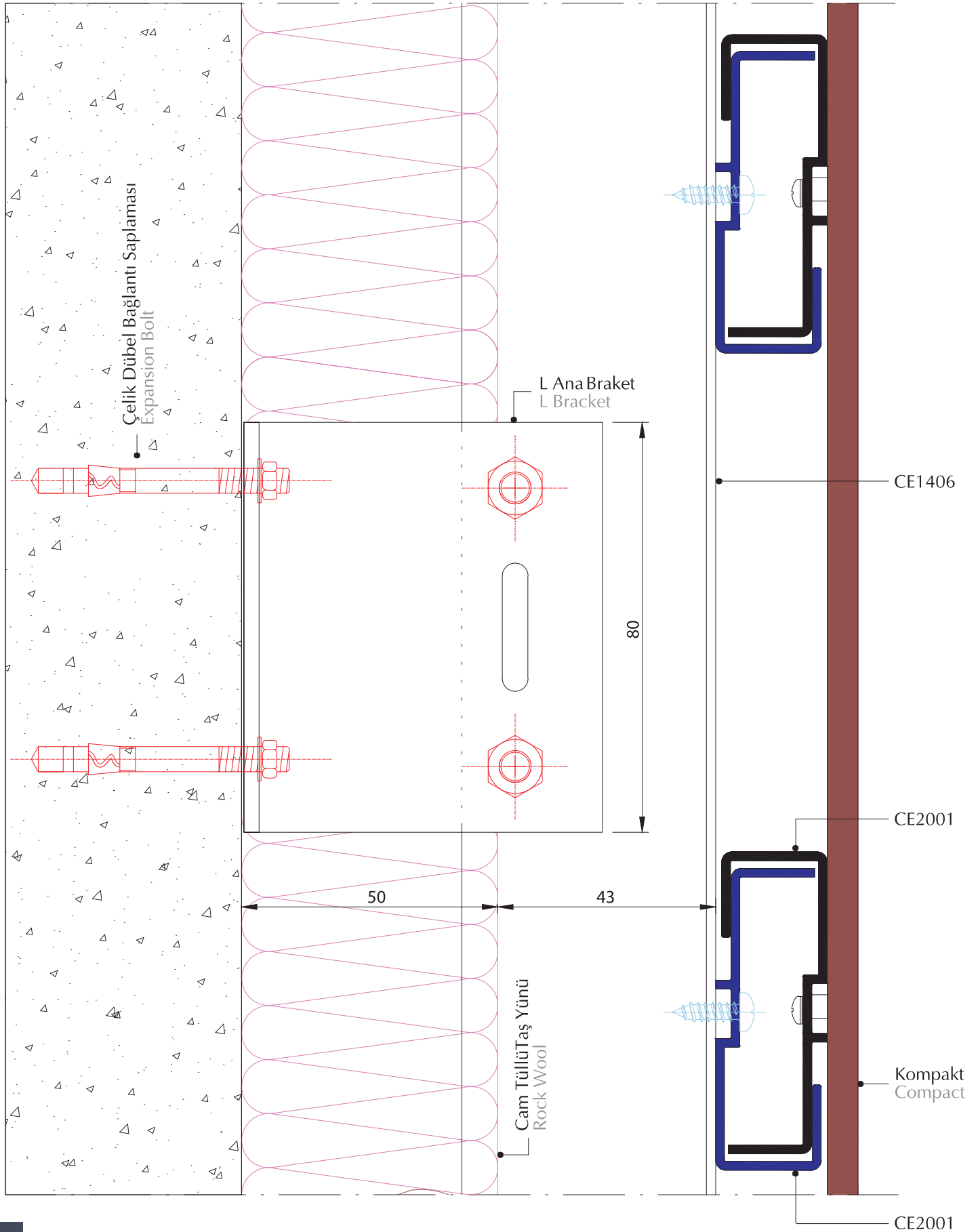

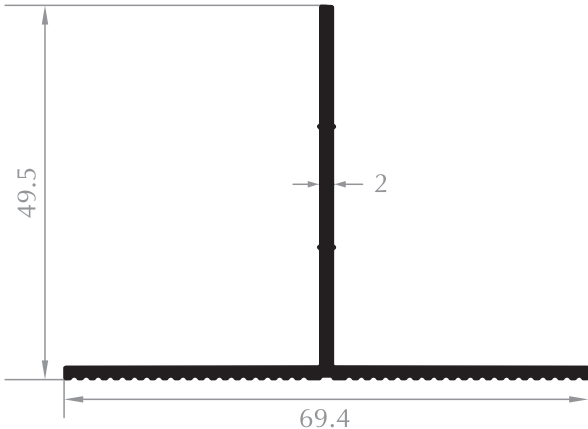

**TIRTIKLİ T  
T PROFILE**

Kod/Code :CE1401  
Ağırlık/Weight :0,618 kg/m

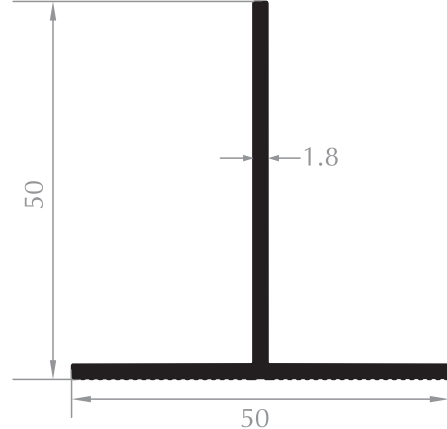

**TIRTIKLİ T  
T PROFILE**

Kod/Code :CE1416  
Ağırlık/Weight :0,507 kg/m

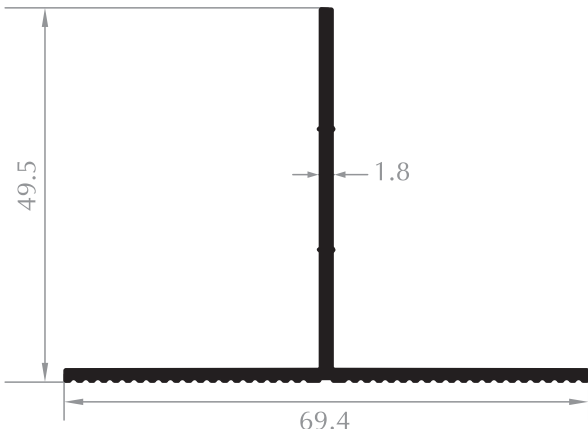

**TIRTIKLİ T  
T PROFILE**

Kod/Code :CE1406  
Ağırlık/Weight :0,545 kg/m

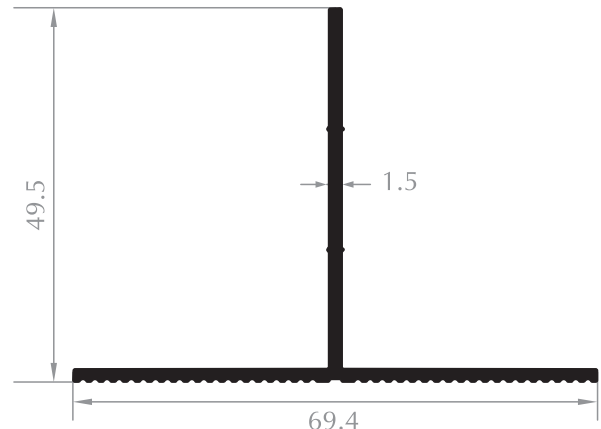

**TIRTIKLİ T  
T PROFILE**

Kod/Code :CE1407  
Ağırlık/Weight :0,451 kg/m

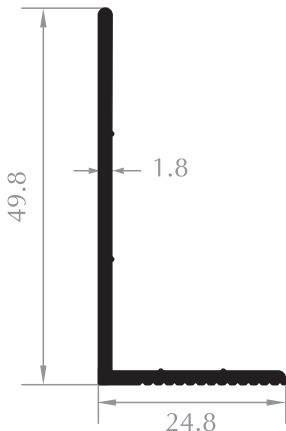

**TIRTIKLİ L  
L PROFILE**

Kod/Code :CE1404  
Ağırlık/Weight :0,350 kg/m

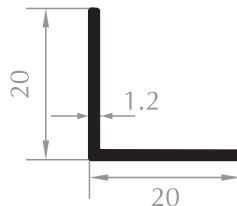

**L PROFİL  
L PROFILE**

Kod/Code :ST2006  
Ağırlık/Weight :0,126 kg/m

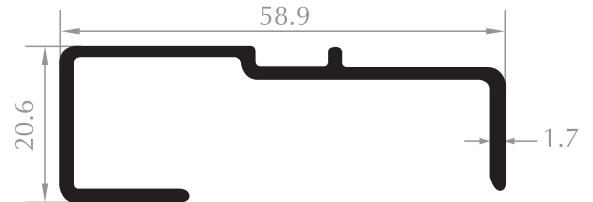

**KOMPAKT LAMİNAT PROFİLİ  
COMPACT LAMİNATE PROFILE**

Kod/Code :CE2001  
Ağırlık/Weight :0,508 kg/m

Braket Listesi Bracket List

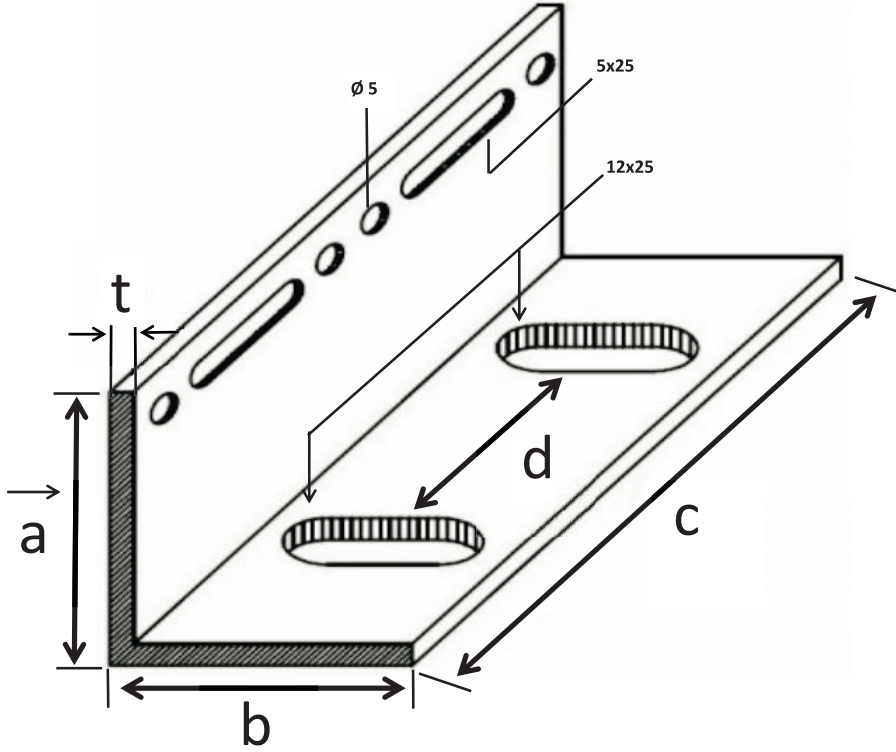

a (mm)	b (mm)	c (mm)	d (mm)	t (mm)
50	50	50	0	3,2
		80	25	
		100	25	
		100	50	
		120	50	
		120	70	
70	50	140	70	
		150	70	
		50	0	
		80	25	
		100	25	
		100	50	
80	50	120	50	
		120	70	
		140	70	
		150	70	
		50	0	
		80	25	
100	50	100	25	
		100	50	
		120	50	
		120	70	
		140	70	
		150	70	
120	50	50	0	
		80	25	
		100	25	
		100	50	
		120	50	
		120	70	
130	50	140	70	
		150	70	
		50	0	
		80	25	
		100	25	
		100	50	
150	50	120	50	
		120	70	
		140	70	
		150	70	
		50	0	
		80	25	